



VISHAY INTERTECHNOLOGY, INC.

# INTERACTIVE

## data book

---

## RACK AND PANEL CONNECTORS

VISHAY DALE

---

VSE-DB0031-1003

### Notes:

1. To navigate:
  - a) Click on the Vishay logo on any datasheet to go to the Contents page for that section. Click on the Vishay logo on any Contents page to go to the main Table of Contents page.
  - b) Click on the products within the Table of Contents to go directly to the datasheet.
  - c) Use the scroll or page up/page down functions.
  - d) Use the Adobe® Acrobat® page function in the browser bar.
2. To search the text of the catalog use the Adobe® Acrobat® search function.



VISHAY INTERTECHNOLOGY, INC.

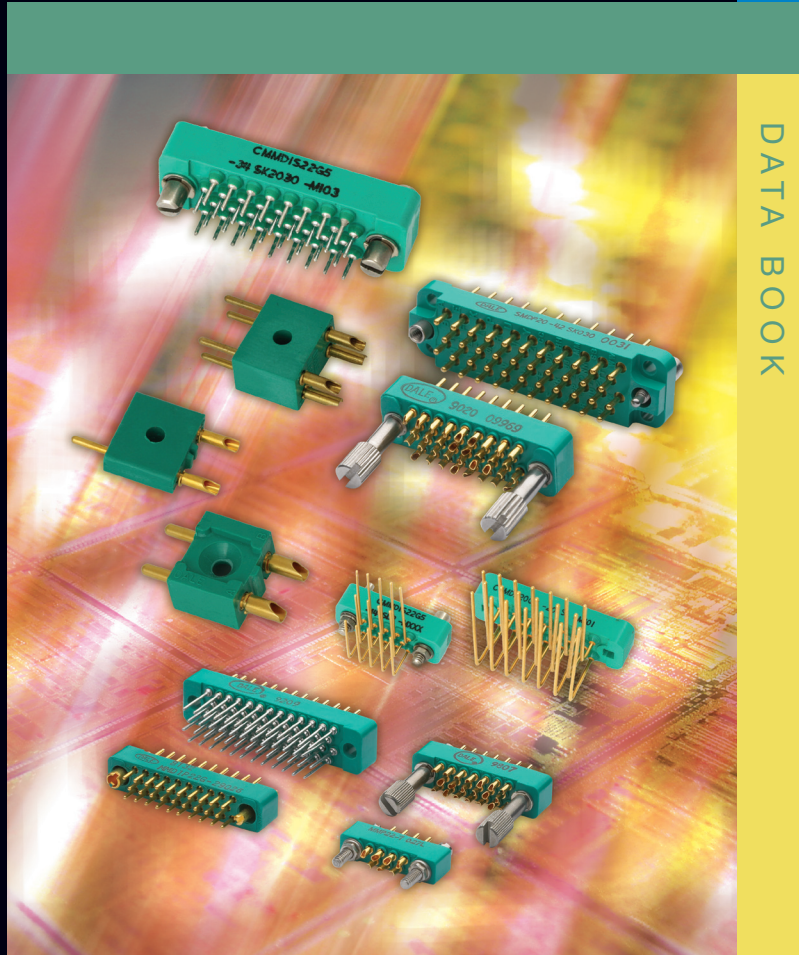

DATA BOOK

## RACK AND PANEL CONNECTORS

VISHAY DALE

Microminiature Rectangular

Subminiature Rectangular

Side Mount

Cross Reference

## SEMICONDUCTORS

### RECTIFIERS

- Schottky (single, dual)
- Standard, Fast and Ultra-Fast Recovery (single, dual)
- Bridge
- Superrectifier®
- Sinterglass Avalanche Diodes

### HIGH-POWER DIODES AND THYRISTORS

- High-Power Fast-Recovery Diodes
- Phase-Control Thyristors
- Fast Thyristors

### SMALL-SIGNAL DIODES

- Schottky and Switching (single, dual)
- Tuner/Capacitance (single, dual)
- Bandswitching
- PIN

### ZENER AND SUPPRESSOR DIODES

- Zener (single, dual)
- TVS (TRANZORB®, Automotive, ESD, Arrays)

### FETs

- Low-Voltage TrenchFET® Power MOSFETs
- High-Voltage TrenchFET® Power MOSFETs
- High-Voltage Planar MOSFETs
- JFETs

### OPTOELECTRONICS

- IR Emitters and Detectors, and IR Receiver Modules
- Optocouplers and Solid-State Relays
- Optical Sensors
- LEDs and 7-Segment Displays
- Infrared Data Transceiver Modules
- Custom Products

### ICs

- Power ICs
- Analog Switches

### MODULES

- Power Modules (contain power diodes, thyristors, MOSFETs, IGBTs)

## PASSIVE COMPONENTS

### RESISTIVE PRODUCTS

- Film Resistors
  - Metal Film Resistors
  - Thin Film Resistors
  - Thick Film Resistors
  - Metal Oxide Film Resistors
  - Carbon Film Resistors
- Wirewound Resistors
- Power Metal Strip® Resistors
- Chip Fuses
- Variable Resistors
  - Cermet Variable Resistors
  - Wirewound Variable Resistors
  - Conductive Plastic Variable Resistors
- Networks/Arrays
- Non-Linear Resistors
  - NTC Thermistors
  - PTC Thermistors
  - Varistors

### MAGNETICS

- Inductors
- Transformers

### CAPACITORS

- Tantalum Capacitors
  - Molded Chip Tantalum Capacitors
  - Coated Chip Tantalum Capacitors
  - Solid Through-Hole Tantalum Capacitors
  - Wet Tantalum Capacitors
- Ceramic Capacitors
  - Multilayer Chip Capacitors
  - Disc Capacitors
- Film Capacitors
- Power Capacitors
- Heavy-Current Capacitors
- Aluminum Capacitors

# Rack and Panel Connectors

**Vishay Dale**  
1505 E. Highway 50  
P.O. Box 180  
Yankton, SD 57078-0180, USA  
**Phone:** +1 605 665 9301  
**Fax:** +1 605 665 1627  
**[www.vishay.com](http://www.vishay.com)**

## **DISCLAIMER**

All product specifications and data are subject to change without notice.

Vishay Intertechnology, Inc., its affiliates, agents, and employees, and all persons acting on its or their behalf (collectively, "Vishay"), disclaim any and all liability for any errors, inaccuracies or incompleteness contained herein or in any other disclosure relating to any product.

Vishay disclaims any and all liability arising out of the use or application of any product described herein or of any information provided herein to the maximum extent permitted by law. The product specifications do not expand or otherwise modify Vishay's terms and conditions of purchase, including but not limited to the warranty expressed therein, which apply to these products.

No license, express or implied, by estoppel or otherwise, to any intellectual property rights is granted by this document or by any conduct of Vishay.

The products shown herein are not designed for use in medical, life-saving, or life-sustaining applications unless otherwise expressly indicated. Customers using or selling Vishay products not expressly indicated for use in such applications do so entirely at their own risk and agree to fully indemnify Vishay for any damages arising or resulting from such use or sale. Please contact authorized Vishay personnel to obtain written terms and conditions regarding products designed for such applications.

Product names and markings noted herein may be trademarks of their respective owners.



---

**Rack and Panel Connectors**

**RACK AND PANEL DATASHEETS**

MM22, MM24 .....	4
MIL-C-28748/7/8 .....	11
SM20 .....	15
A20, WA20 .....	19
G20 .....	21
G16 .....	22

**COMPETITOR PRODUCTS CROSS-REFERENCED TO VISHAY DALE CONNECTORS**

Continental .....	24
Positronics .....	34
U.S. Components .....	41
Winchester .....	50



---

Vishay Dale



# Rack and Panel Datasheets

## Contents

MM22, MM24 .....	4
MIL-C-28748/7/8 .....	11
SM20 .....	15
A20, WA20 .....	19
G20 .....	21
G16 .....	22



# Rack and Panel Connectors Military, MIL-C-28748/7/8 Qualified and Commercial Microminiature Rectangular with Optional Hoods



### FEATURES

- Qualified to MIL-C-28748/7/8
- Solder cup contacts
- Dip solder contacts
- Fixed and turnable screwlocks
- Optional closed entry socket contacts

### APPLICATIONS

Especially suited for use in airborne, instrumentation and portable equipment applications or wherever the following requirements must be met: Minimum space and weight without sacrifice of performance, high quality materials, long service life, high vibration and shock resistance and positive locking.

### ELECTRICAL SPECIFICATIONS

**Current Rating:** Model MM22 = 5 A

Model MM24 = 3 A

**Breakdown Voltage:** At sea level: 2000 V<sub>RMS</sub>

At 70 000 feet: 500 V<sub>RMS</sub>

### MATERIAL SPECIFICATIONS

**Contact Pin:** Phosphor bronze

**Contact Socket:** Phosphor bronze (Beryllium copper available on request)

**Contact Plating:** Gold

**Screwlocks:** Stainless steel, passivated

**Guides:** Brass, gold plated or stainless steel, passivated

**Standard Body:** Glass-filled diallyl phthalate per MIL-M-14, Model SDG-F, green

DIMENSIONS in inches [millimeters]					
MMS With Solder Cup Contacts		MMP With Solder Cup Contacts		MMDS With Dip Solder Contacts	MMDP With Dip Solder Contacts
CONTACT GAUGE	B DIAMETER	CONTACT GAUGE	C DIP TAIL LENGTH	D DIAMETER	
22 AWG	0.030 ± 0.001 [0.762 ± 0.025]	22 AWG	0.160 or 0.350 [4.06 or 8.89] nom.	0.025 [0.635]	
24 AWG	0.025 ± 0.001 [0.635 ± 0.025]	24 AWG	0.160 or 0.350 [4.06 or 8.89] nom.	0.025 [0.635]	

Rack and Panel Connectors Military, MIL-C-28748/7/8  
 Qualified and Commercial Microminiature Rectangular  
 with Optional Hoods

Vishay Dale

<b>DIMENSIONS</b> in inches [millimeters]				
		<b>HARDWARE TYPE</b>	<b>E DIAMETER</b>	<b>F DIAMETER</b>
<p><b>MMS</b> With Fixed (026, 027) Guides</p> <p>0.520 [13.21] 0.230 [5.84] 2-56 UNC-2A Thread Typ. 0.140 [3.56] 0.030 [0.762] Wide x 0.040 [1.02] Deep Slot Typ. 0.110 [2.79] 0.034 [0.864] Dia. Solder Cup #22 or #24 AWG Max. F Dia.</p>	<p><b>MMP</b> With Fixed (026, 027) Guides</p> <p>0.490 [12.45] 0.230 [5.84] "A" End of Connector 0.140 [3.56] E Dia.</p>	026	0.078 [1.98]	0.125 [3.17]
		026L	0.078 [1.98]	0.125 [3.17]
		027	0.078 [1.98]	0.125 [3.17]
		027L	0.078 [1.98]	0.125 [3.17]
<p><b>MMS</b> With Fixed (026L, 027L) Guides</p> <p>0.620 [15.75] 0.230 [5.84] 0.140 [3.56] 0.040 [1.02] Typ. 0.034 [0.864] Dia. Solder Cup #22 or #24 AWG Max. 0.030 [0.762] Typ. 0.110 [2.79]</p>	<p><b>MMP</b> With Fixed (026L, 027L) Guides</p> <p>"A" End of Connector 0.590 [14.99] 0.250 [6.35] 2-56 UNC-2A Typ.</p>	<p><b>Short Turnable Screwlocks (SK030)</b></p> <p>0.540 [13.72] 0.160 [4.06] 0.030 [0.762] Wide x 0.040 [1.02] Deep Typ. 0.124 [3.15] Dia. 0.110 [2.79] 0.500 [12.70]</p>	<p><b>Turnable Screwlocks (SK)</b></p> <p>0.950 [24.13] 0.046 [1.17] Wide x 0.062 [1.57] Deep Typ. 0.187 [4.75] Dia. 0.110 [2.79] 0.910 [23.11]</p>	
<p><b>Fixed Screwlocks (SL)</b></p> <p>0.490 [12.45] 0.140 [3.56] 0.520 [13.21]</p>	<p><b>Fixed Screwlocks (SLL)</b></p> <p>0.620 [15.75] 0.230 [5.84] 0.140 [3.56] 0.034 [0.864] Dia. Solder Cup #22 or #24 AWG Max. 0.250 [6.35] 0.590 [14.99] 0.110 [2.79]</p>	<p><b>Fixed Screwlocks And Nylon Retaining Nut And Fiber Washer (NSL)</b></p> <p>0.590 [14.99] 0.620 [15.75]</p>	<p><b>Short Turnable Screwlocks (SK2035)</b></p> <p>0.610 [15.49] 0.240 [6.10] Typ. 0.093 [2.36] Hex Socket 0.090 [2.29] Deep Typ. 0.180 [4.57] Dia. 0.580 [14.73] 0.110 [2.79]</p>	

HARDWARE MATING CHART		NOTE: Either MMP or MMS Connectors may be ordered with any type of hardware shown.
HARDWARE MODEL	MATES WITH HARDWARE MODEL	
026	026, 026L	<b>EXAMPLES:</b> 1. MMP with 026 Hardware would mate with an MMS with 026 Hardware. 2. MMS with SK Hardware would mate with an MMP with SL or NSL Hardware. 3. MMS with SL2 Hardware would mate with an MMP with SK2 or SK2030 Hardware.
027	027, 027L	
SK	SL, NSL or SLL	
SK030	SL, NSL or SLL	
SK2	SL2, NSL2 or SL2L	
SK2030	SL2, NSL2 or SL2L	
SK2035	SL2, NSL2 or SL2L	

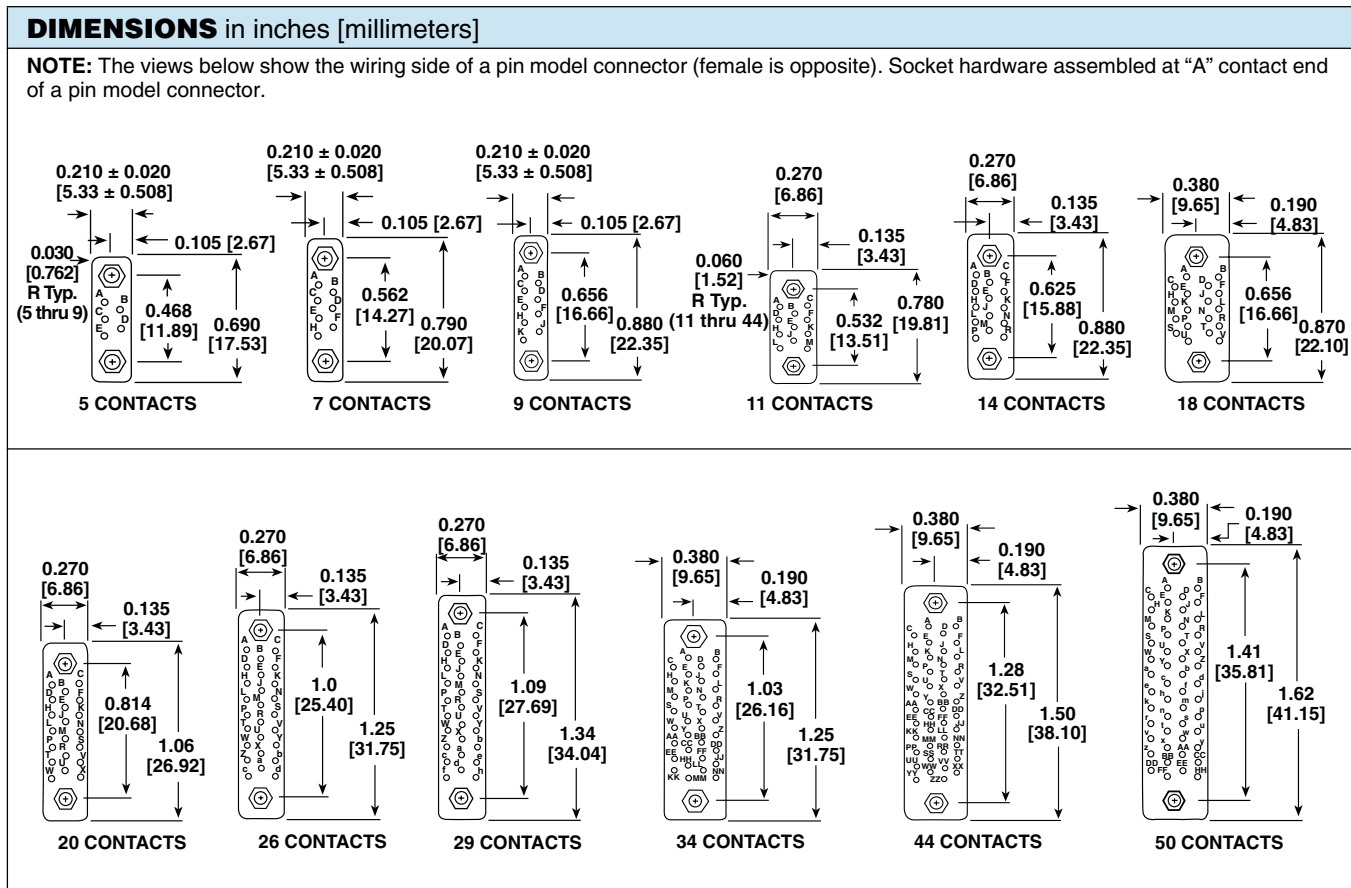

Rack and Panel Connectors Military, MIL-C-28748/7/8  
 Qualified and Commercial Microminiature Rectangular  
 with Optional Hoods

Vishay Dale

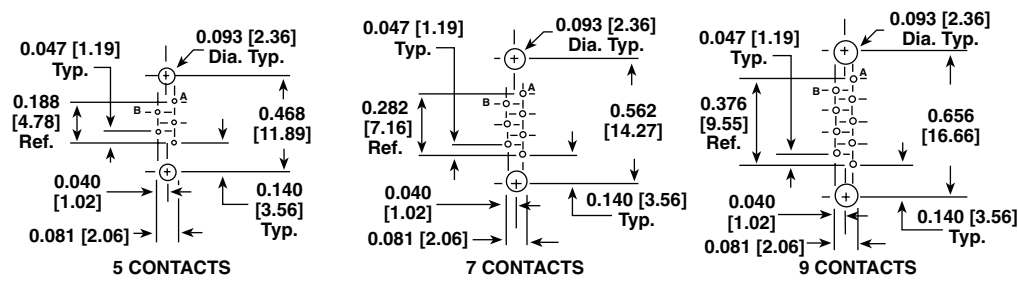
**MOUNTING VARIATIONS** in inches [millimeters]

**DIP SOLDER PC BOARD MOUNTING PATTERNS**  
 Male (MMP) connector shown - female is opposite. Contact, contact row and mating hole  $C_L$  to  $C_L$ . Dimensions also applies to solder cup style connectors.

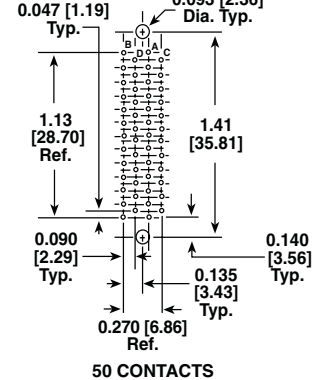
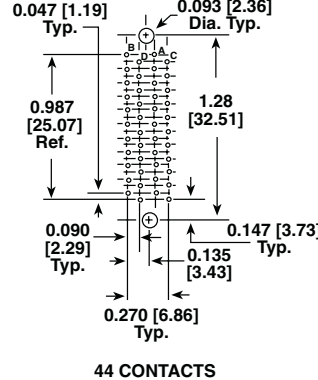
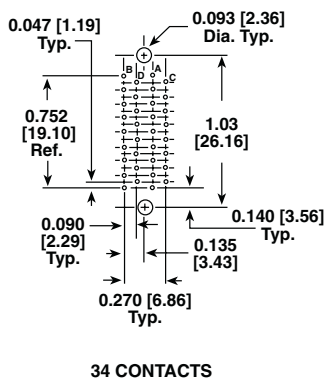
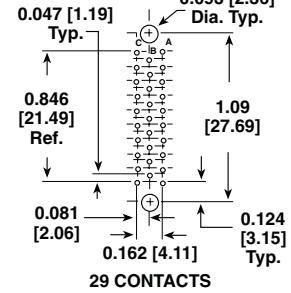
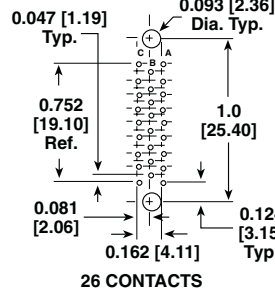
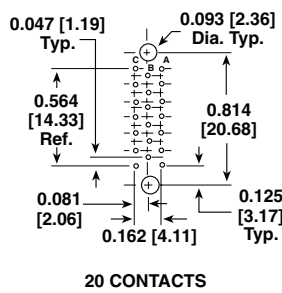
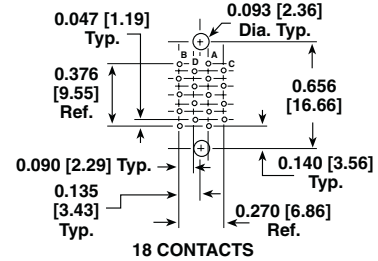
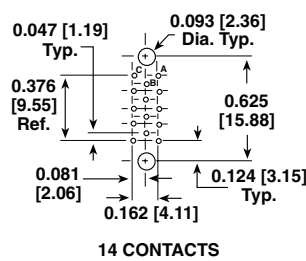
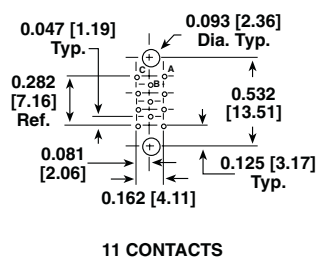

PANEL CUTOUT in inches [millimeters]								
	NUMBER OF CONTACTS	A	B	C	NUMBER OF CONTACTS	A	B	C
	5	0.210 [5.33]	0.468 [11.89]	0.340 [8.64]	20	0.270 [6.86]	0.814 [20.68]	0.690 [17.53]
	7	0.210 [5.33]	0.562 [14.27]	0.440 [11.18]	26	0.270 [6.86]	1.0 [25.40]	0.870 [22.10]
	9	0.210 [5.33]	0.656 [16.66]	0.530 [13.46]	29	0.270 [6.86]	1.09 [27.69]	0.970 [24.64]
	11	0.270 [6.86]	0.532 [13.51]	0.410 [10.41]	34	0.380 [9.65]	1.03 [26.16]	0.910 [23.11]
	14	0.270 [6.86]	0.625 [15.88]	0.500 [12.70]	44	0.380 [9.65]	1.28 [32.51]	1.16 [29.46]
	18	0.380 [9.65]	0.656 [16.66]	0.530 [13.46]	50	0.380 [9.65]	1.41 [35.81]	1.28 [32.51]

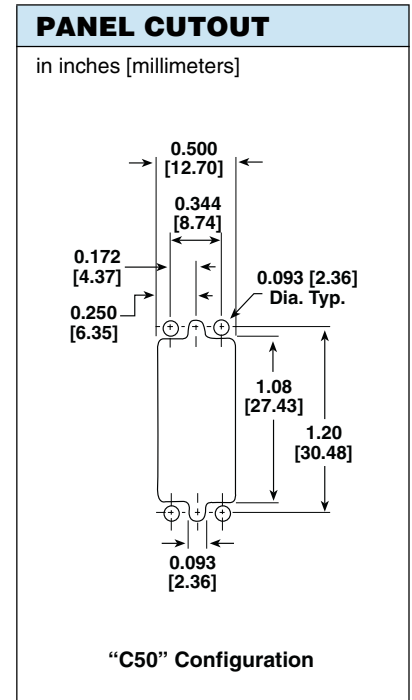
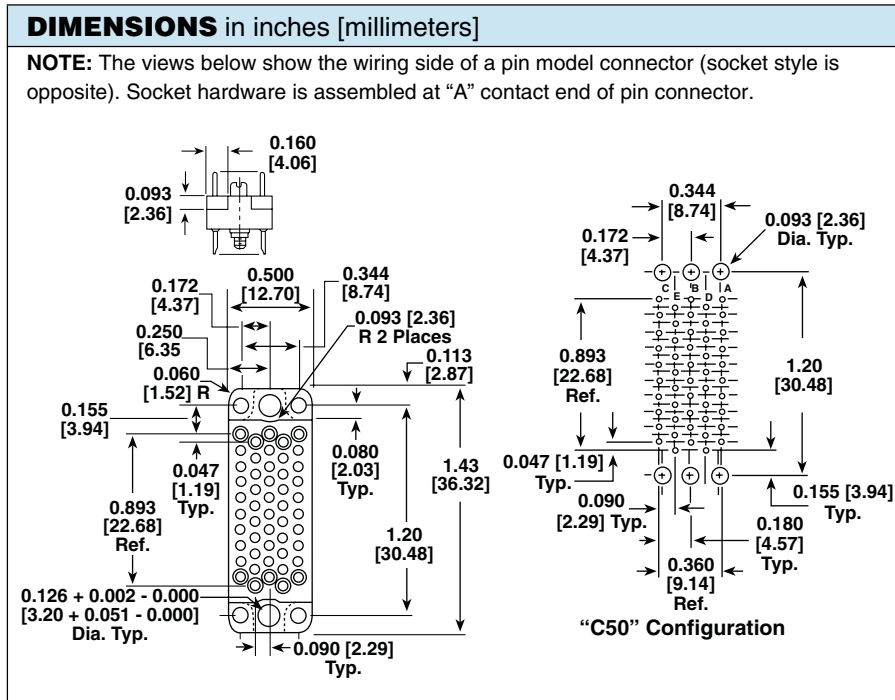

**DIP SOLDER PC BOARD MOUNTING PATTERNS**

Male (MMP) connector shown - female is opposite. Contact, contact row and mating hole C<sub>L</sub> to C<sub>L</sub> dimensions also applies to solder cup style connectors.

Rack and Panel Connectors Military, MIL-C-28748/7/8  
 Qualified and Commercial Microminiature Rectangular  
 with Optional Hoods

Vishay Dale

**HOOD VARIATIONS** in inches [millimeters]

NUMBER OF CONTACTS	A ± 0.016 [0.406]	B ± 0.030 [0.76]	C	D ± 0.016 [0.406]	"E" CABLE OPENING SQ. IN. [mm <sup>2</sup> ]
5	0.690 [17.53]	0.650 [16.51]	0.468 [11.89]	0.310 [7.87]	0.028 [0.711]
7	0.780 [19.81]	0.650 [16.51]	0.562 [14.27]	0.440 [11.18]	0.037 [0.940]
9	0.870 [22.10]	0.650 [16.51]	0.656 [16.66]	0.500 [12.70]	0.052 [1.321]
11	0.780 [19.81]	0.650 [16.51]	0.532 [13.51]	0.440 [11.18]	0.054 [1.372]
14	0.870 [22.10]	0.650 [16.51]	0.625 [15.88]	0.500 [12.70]	0.076 [1.930]
20	1.06 [26.92]	0.650 [16.51]	0.814 [20.68]	0.620 [15.75]	0.105 [2.667]
26	1.25 [31.75]	0.650 [16.51]	1.00 [25.40]	0.620 [15.75]	0.105 [2.667]
29	1.34 [34.04]	0.650 [16.51]	1.09 [27.67]	0.620 [15.75]	0.105 [2.667]
34	1.25 [31.75]	0.650 [16.51]	1.03 [26.16]	0.500 [12.70]	0.160 [4.064]
44	1.50 [38.10]	1.17 [29.72]	1.28 [32.51]	0.500 [12.70]	0.190 [4.826]
50	1.62 [41.15]	1.17 [29.72]	1.41 [35.81]	0.620 [15.75]	0.202 [5.131]

## ORDERING INFORMATION

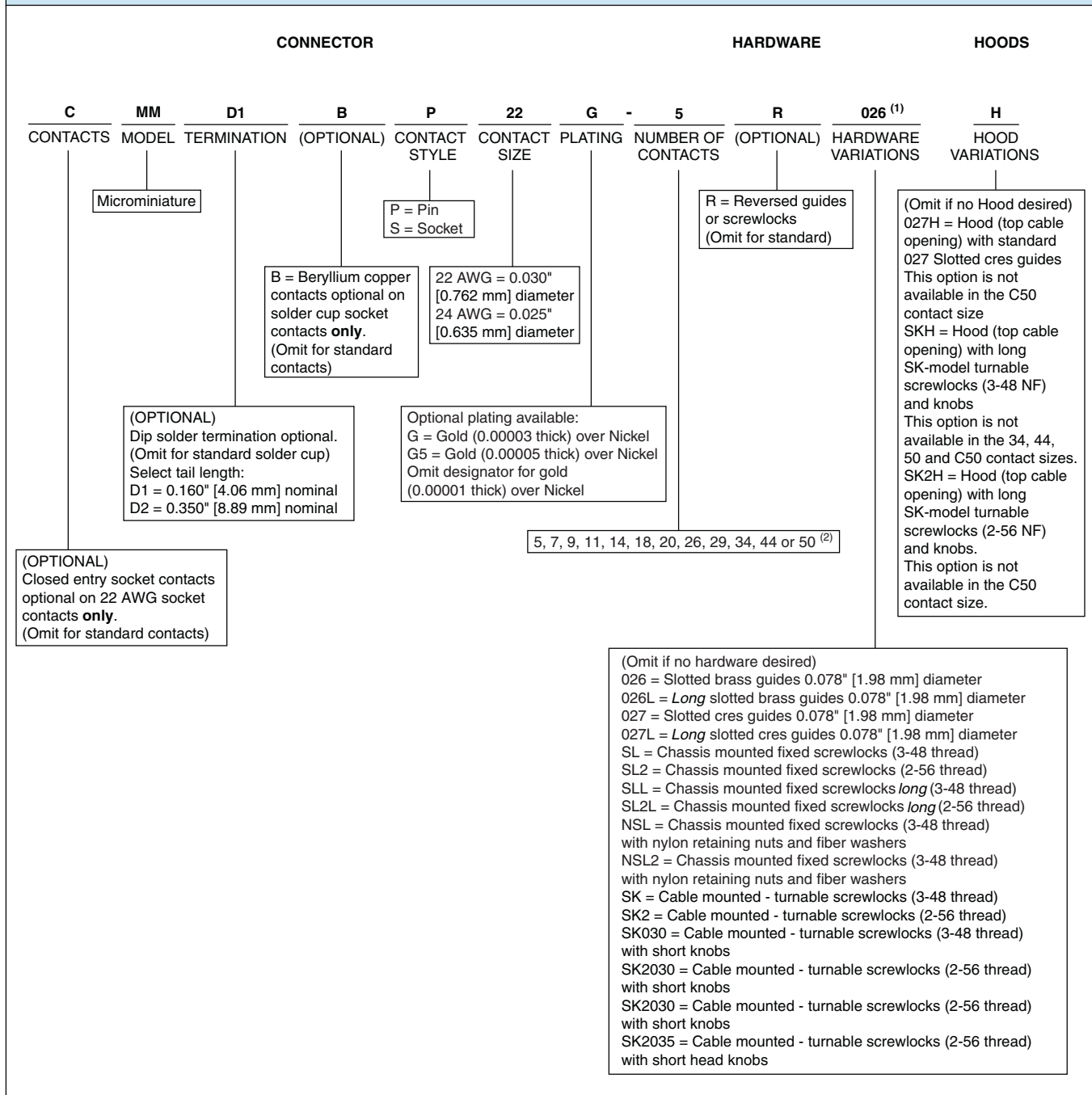

### Notes

(1) To order complete connector with hardware supplied unassembled, add suffix "UA" on end of hardware designation.

(2) 50 contact connectors are available in either the standard 4-row contact arrangement per MIL-C-28748 or a special 5-row contact arrangement. To order the special 5-row contact arrangement, use the designator "C50" for the number of contacts.



## Rack and Panel Connectors Military, MIL-C-28748/7/8 Qualified Microminiature Rectangular with Optional Hoods



### FEATURES

- Qualified to MIL-C-28748/7/8
- Solder cup contacts
- Fixed and turnable screwlocks
- Closed entry socket contacts
- Group A, B testing per MIL-C-28748

### APPLICATIONS

Especially suited for use in airborne, instrumentation and portable equipment applications or wherever the following requirements must be met: Minimum space and weight without sacrifice of performance, high quality materials, long service life, high vibration and shock resistance and positive locking.

### ELECTRICAL SPECIFICATIONS

**Current Rating:** Model MM22 = 5 A

**Breakdown Voltage:** At sea level: 2000 V<sub>RMS</sub>

At 70 000 feet: 500 V<sub>RMS</sub>

### MATERIAL SPECIFICATIONS

**Contact Pin:** Phosphor bronze

**Contact Socket:** Phosphor bronze

**Contact Plating:** Gold 50 micro-inches per ASTM B488

**Screwlocks:** Stainless steel, passivated

**Guides:** Stainless steel, passivated

**Standard Body:** Glass-filled diallyl phthalate per ASTM D5948, Model SDG-F, green

### DIMENSIONS in inches [millimeters]

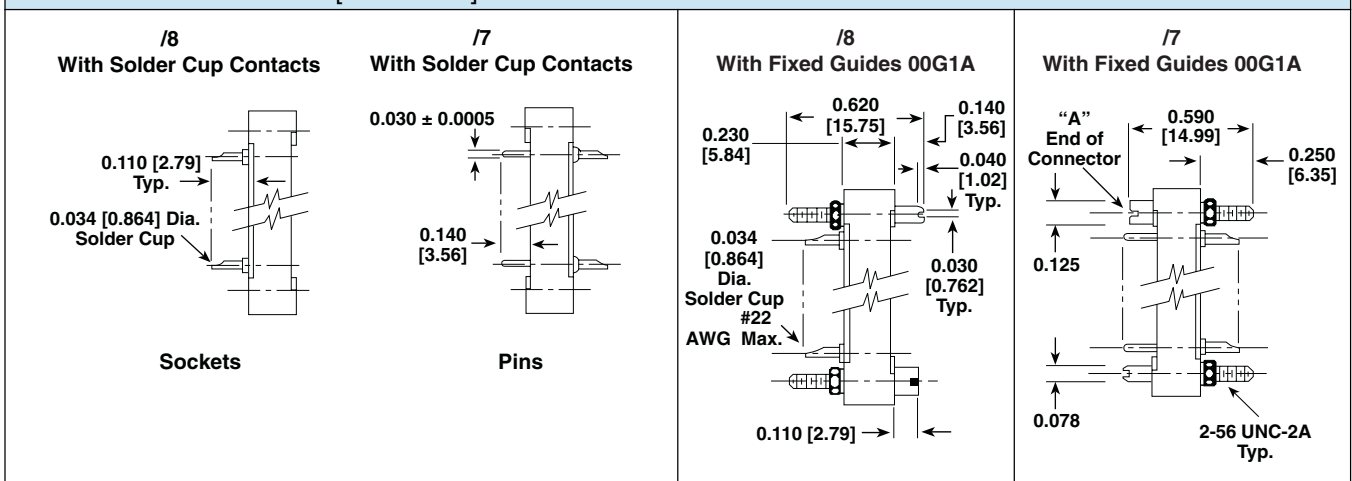



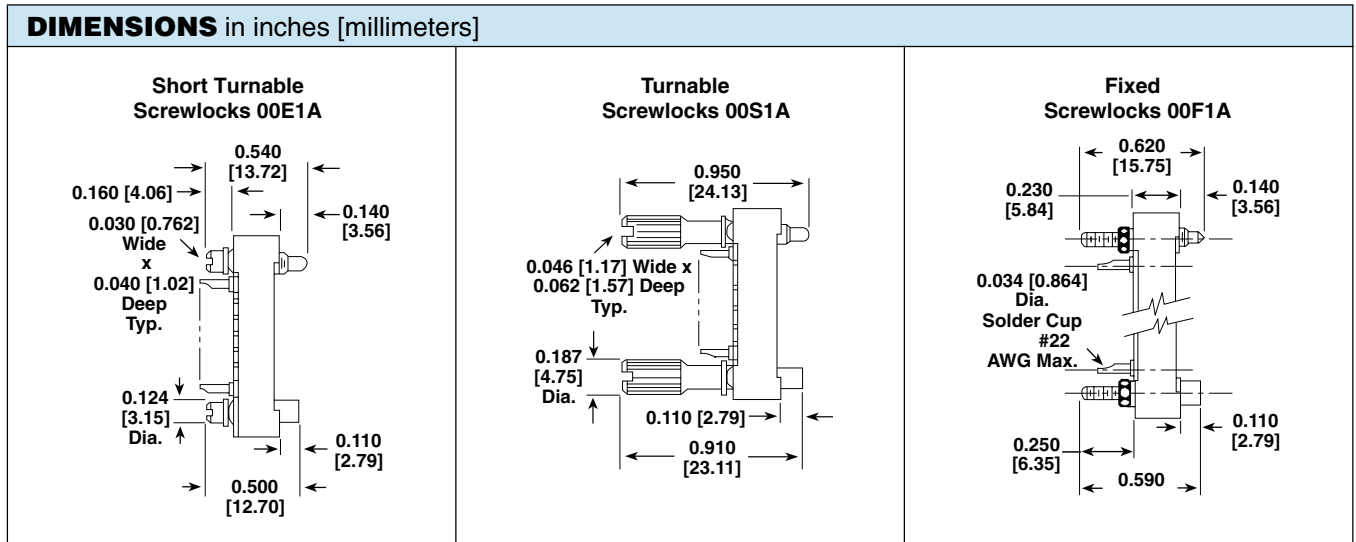

**HARDWARE MATING CHART**

HARDWARE MODEL	MATES WITH HARDWARE MODEL	NOTE:
00S1A	00F1A	Either /7 or /8 connectors may be ordered with any type of hardware shown <b>EXAMPLE:</b> /8 with 00F1A hardware would mate with an MMP with 00S1A or 00E1A hardware
00E1A	00F1A	

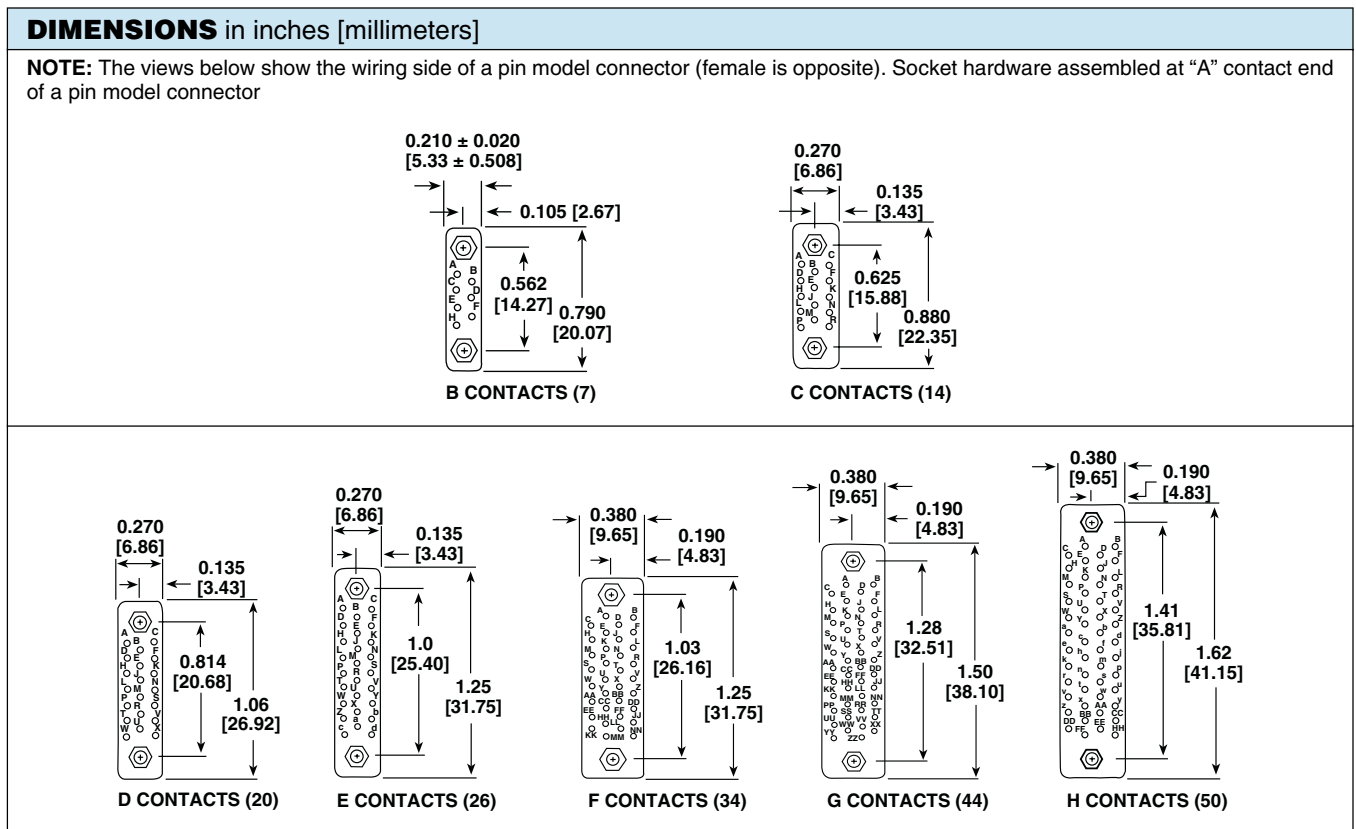

**Rack and Panel Connectors Military, MIL-C-28748/7/8**  
**Qualified Microminiature Rectangular with Optional Hoods**

Vishay Dale

<b>PANEL CUTOUT</b> in inches [millimeters]								
	NUMBER OF CONTACTS	A	B	C	NUMBER OF CONTACTS	A	B	C
	B (7)	0.210 [5.33]	0.562 [14.27]	0.440 [11.18]	F (34)	0.380 [9.65]	1.03 [26.16]	0.910 [23.11]
	C (14)	0.270 [6.86]	0.625 [15.88]	0.500 [12.70]	G (44)	0.380 [9.65]	1.28 [32.51]	1.16 [29.46]
	D (20)	0.270 [6.86]	0.814 [20.68]	0.690 [17.53]	H (50)	0.380 [9.65]	1.41 [35.81]	1.28 [32.51]
	E (26)	0.270 [6.86]	1.0 [25.40]	0.870 [22.10]				

<b>HOOD VARIATIONS</b> in inches [millimeters]					
<p><b>10G1A</b></p> <p>B CONTACTS (7)</p> <p>C, D, E CONTACTS (14, 20, 26)</p> <p>F, G, H CONTACTS (34, 44, 50)</p>		<p><b>10L1A</b></p> <p>B CONTACTS (7)</p> <p>C, D, E CONTACTS (14, 20, 26)</p> <p>F, G, H CONTACTS (34, 44, 50)</p>		<p><b>10H1A</b></p> <p>B CONTACTS (7)</p> <p>C, D, E CONTACTS (14, 20, 26)</p> <p>F, G, H CONTACTS (34, 44, 50)</p>	
NUMBER OF CONTACTS	± 0.016 [0.406]	± 0.030 [0.76]	C	± 0.016 [0.406]	“E” CABLE OPENING INCH <sup>2</sup> [mm <sup>2</sup> ]
B (7)	0.780 [19.81]	0.650 [16.51]	0.562 [14.27]	0.440 [11.18]	0.037 [0.940]
C (14)	0.870 [22.10]	0.650 [16.51]	0.625 [15.88]	0.500 [12.70]	0.076 [1.930]
D (20)	1.06 [26.92]	0.650 [16.51]	0.814 [20.68]	0.620 [15.75]	0.105 [2.667]
E (26)	1.25 [31.75]	0.650 [16.51]	1.00 [25.40]	0.620 [15.75]	0.105 [2.667]
F (34)	1.25 [31.75]	0.650 [16.51]	1.03 [26.16]	0.500 [12.70]	0.160 [4.064]
G (44)	1.50 [38.10]	1.17 [29.72]	1.28 [32.51]	0.500 [12.70]	0.190 [4.826]
H (50)	1.62 [41.15]	1.17 [29.72]	1.41 [35.81]	0.620 [15.75]	0.202 [5.131]

**ORDERING INFORMATION**

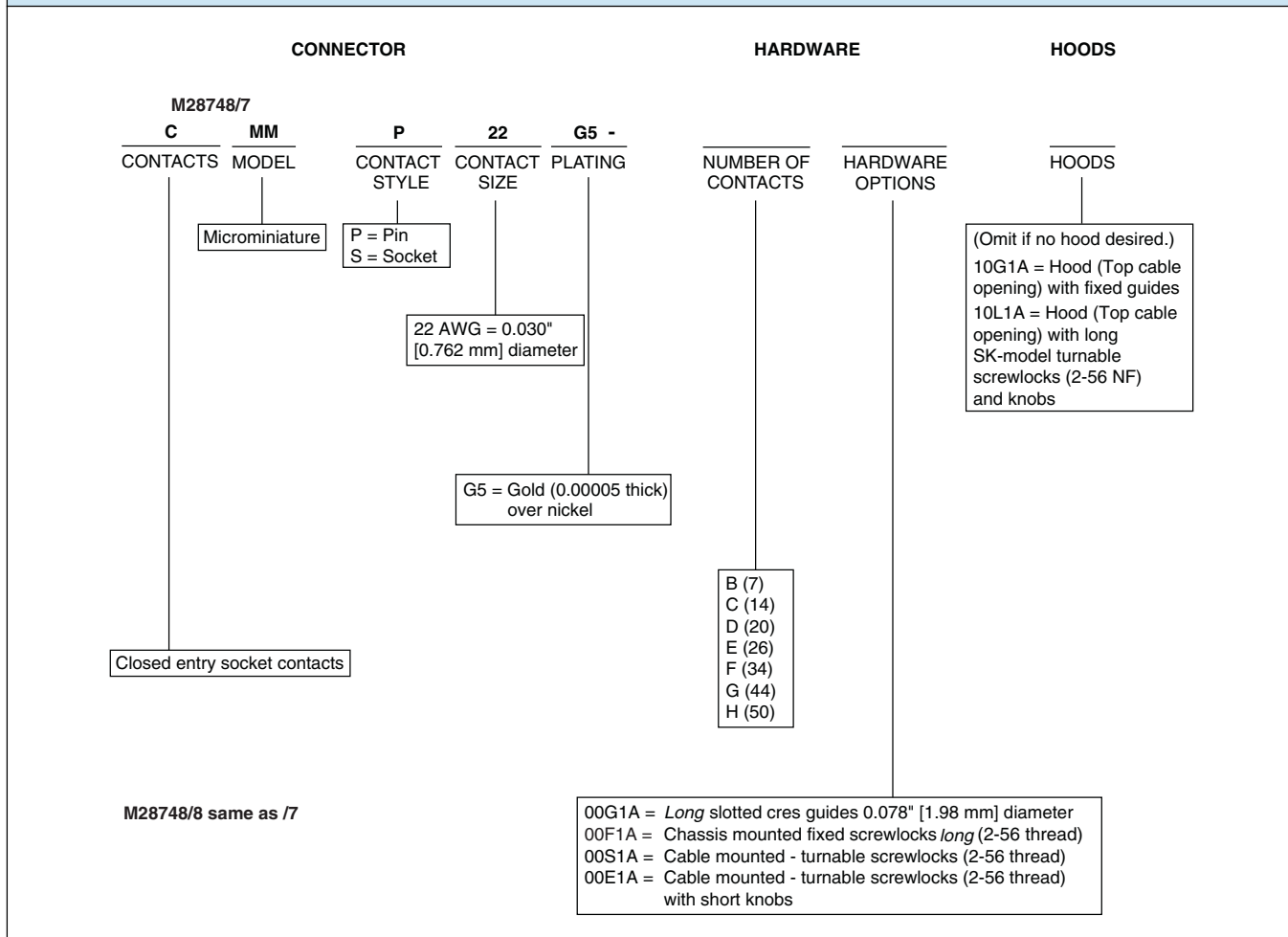

# Rack and Panel Connectors Subminiature Rectangular

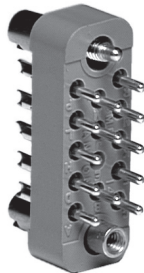
**SMP20**

**SMS20**

## ELECTRICAL SPECIFICATIONS

**Current Rating:** 7.5 A

**Breakdown Voltage:**

At sea level: 2000 V<sub>RMS</sub>

At 70 000 feet [21 336 meters]: 500 V<sub>RMS</sub>

## PHYSICAL SPECIFICATIONS

**Number of Contacts:** 5, 7, 11, 14, 20, 26, 34, 42, 50, 75

**Contact Spacing:** 0.120" [3.05 mm]

**Contact Gauge:** #20 AWG

**Minimum Creepage Path Between Contacts:**  
0.080" [2.03 mm]

**Minimum Air Space Between Contacts:** 0.050" [1.27 mm]

## FEATURES

- Lightweight
- Polarized by guides or screwlocks
- Screwlocks lock connectors together to withstand vibration and accidental disconnect
- Overall height kept to a minimum
- Floating contacts aid in alignment and in withstanding vibration
- Contacts, precision machined and individually gauged, provide high reliability
- Insertion and withdrawal forces kept low without increasing contact resistance
- Contact plating provides protection against corrosion, assures low contact resistance and ease of soldering

## APPLICATIONS

For use wherever space is at a premium and a high quality connector is required in avionics, automation, communications, controls, instrumentation, missiles, computers and guidance systems.

## MATERIAL SPECIFICATIONS

**Contact Pin:** Brass, gold plated

**Contact Socket:** Phosphor bronze, gold plated  
(Beryllium copper available on request)

**Guides:** Stainless steel, passivated

**Screwlocks:** Stainless steel, passivated

**Standard Body:** Glass-filled diallyl phthalate per MIL-M-14, Model GDI-30F, green

## DIMENSIONS in inches [millimeters]

SMS With Fixed Standard Guides	SMDS - DETAIL B Dip Solder Contact Option	SMP With Fixed Standard Guides	SMDP - DETAIL C Dip Solder Contact Option

**DIMENSIONS** in inches [millimeters]

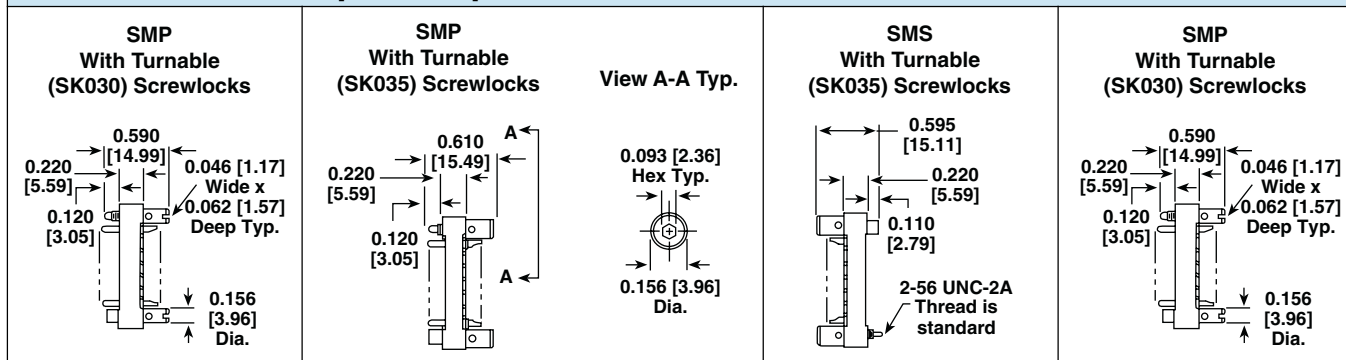

View A-A Typ.



**TERMINAL VARIATIONS** in inches [millimeters]

**DIP SOLDER PC BOARD MOUNTING PATTERNS**

Male (SMP) Connector is shown - Female is opposite. Contact row and Mating Hole  $\varnothing$  to  $\varnothing$  Dimensions also applies to Solder Cup Connectors.

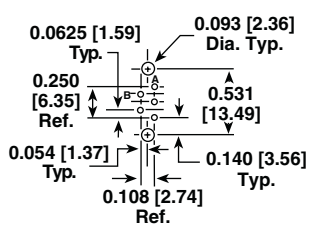

5 CONTACTS

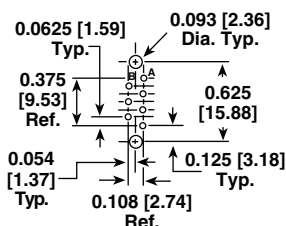

7 CONTACTS

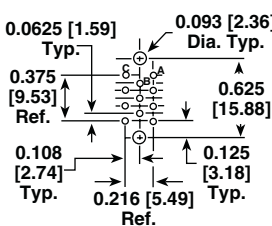

11 CONTACTS

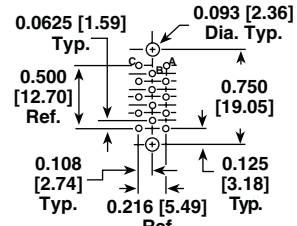

14 CONTACTS

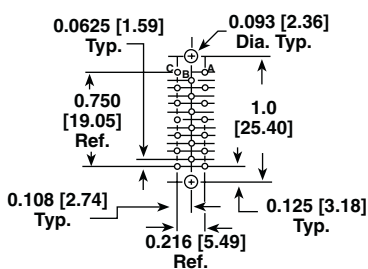

20 CONTACTS

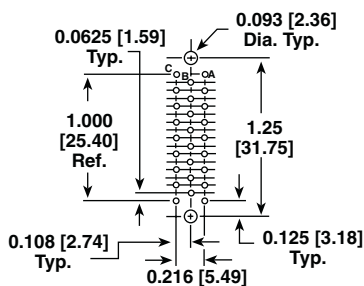

26 CONTACTS

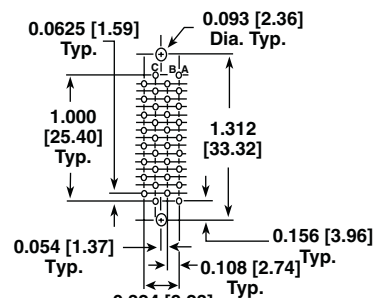

34 CONTACTS

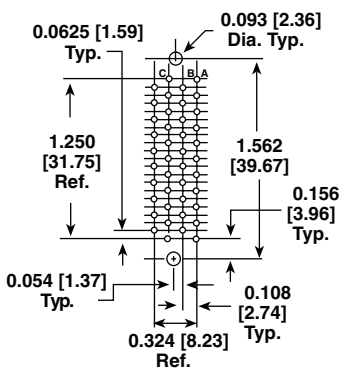

42 CONTACTS

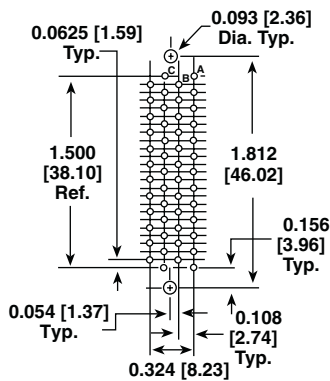

50 CONTACTS

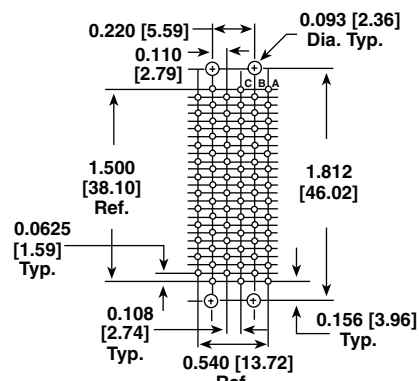

75 CONTACTS

**DIMENSIONS** in inches [millimeters]

**NOTE:** The views below show the wiring side of a pin model connector (female is opposite). Socket hardware is assembled at "A" contact end of a pin model connector.

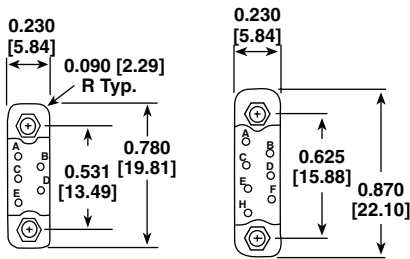

5 CONTACTS

7 CONTACTS

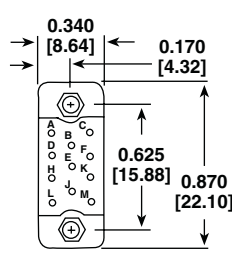

11 CONTACTS

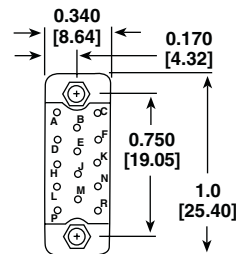

14 CONTACTS

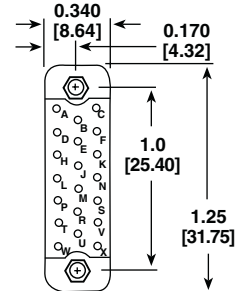

20 CONTACTS

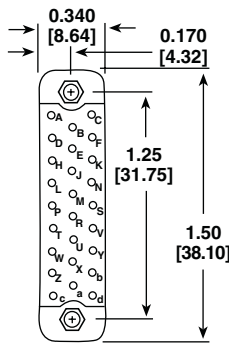

26 CONTACTS

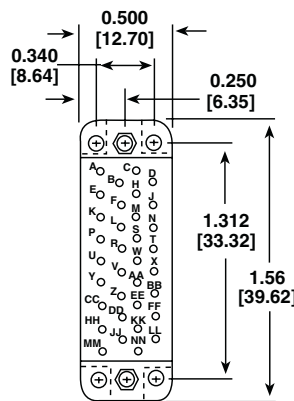

34 CONTACTS

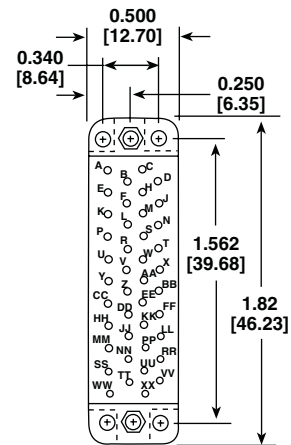

42 CONTACTS

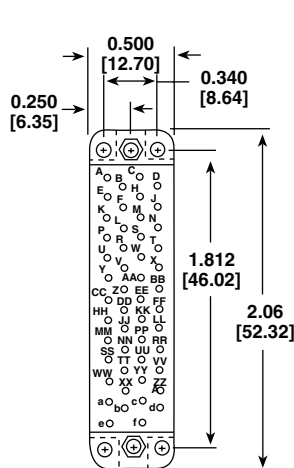

50 CONTACTS

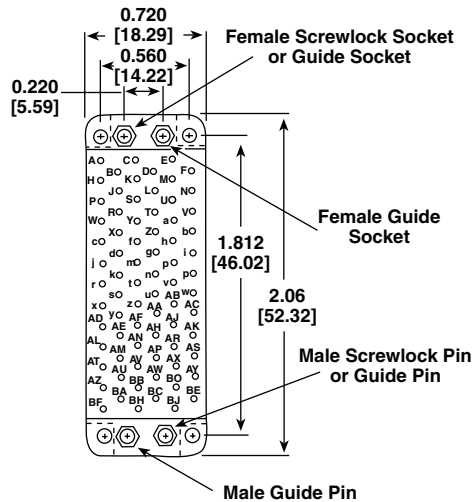

75 CONTACTS

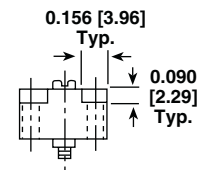
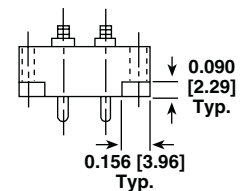
 TYPICAL END VIEW  
34 THRU 50 CONTACTS

 TYPICAL END VIEW  
75 CONTACTS

PANEL CUTOUT in inches [millimeters]								
		NUMBER OF CONTACTS	A	B	C	D	FIGURE	
<p>FIGURE I</p>	<p>FIGURE II</p>	<p>FIGURE III</p>	5	0.230 [5.84]	0.531 [13.49]	0.410 [10.41]	-	I
			7	0.230 [5.84]	0.625 [15.88]	0.500 [12.70]	-	
			11	0.340 [8.64]	0.625 [15.88]	0.530 [13.46]	-	
			14	0.340 [8.64]	0.750 [19.05]	0.620 [15.75]	-	
			20	0.340 [8.64]	1.0 [25.40]	0.910 [23.11]	-	
			26	0.340 [8.64]	1.25 [31.75]	1.16 [29.46]	-	
			34	0.500 [12.70]	1.312 [33.32]	1.16 [29.46]	0.343 [8.71]	
42	0.500 [12.70]	1.562 [39.68]	1.41 [35.81]	0.343 [8.71]				
50	0.500 [12.70]	1.812 [46.02]	1.66 [42.16]	0.343 [8.71]				
75	0.720 [18.29]	1.812 [46.02]	1.66 [42.16]	0.562 [14.28]	III			

### ORDERING INFORMATION

<b>C</b> CONTACTS	<b>SM</b> MODEL	<b>B</b> CONTACT TYPE	<b>S</b> CONTACT STYLE	<b>20</b> CONTACT SIZE	<b>G</b> PLATING	<b>26</b> NUMBER OF CONTACTS	<b>R</b> (OPTIONAL)	<b>027<sup>(1)</sup></b> HARDWARE OPTIONS
	Subminiature		P = Pin S = Socket	#20 AWG		5, 7, 11, 14, 20, 26, 34, 42, 50, 75		
(OPTIONAL) Closed entry socket contacts only. Omit for standard contacts.					Optional plating available: G = Gold (0.00003 thick) over nickel G5 = Gold (0.00005 thick) over nickel Omit designator for gold (0.00001 thick) over nickel		(OPTIONAL) R = Reversed guides or screwlocks Omit for standard	
		(OPTIONAL) B = Beryllium copper, socket contacts (Solder cup) D = Dip solder contacts						(Omit if no hardware desired) 027 = Slotted cres guides 0.090" [2.29 mm] diameter SK = Turnable screwlocks with 2-56 threads SK3 = Turnable screwlocks with 3-48 threads SL = Fixed screwlocks with 2-56 threads SL3 = Fixed screwlocks with 3-48 threads SK030 = Turnable screwlocks with short slotted knobs SK035 = Turnable screwlocks with socket head knobs SK3030 = Turnable screwlocks with short slotted knobs with 3-48 threads SK3035 = Turnable screwlocks with socket head knobs with 3-48 threads

**EXAMPLES:**  
 SMBS20-26SK035 = Female, 26 beryllium copper socket contacts with socket head knobs on turnable screwlocks for #20 AWG wiring.  
 SMP20-14SL3 = Male, 14 contact pins, fixed screwlocks with 3-48 threads for #20 AWG wiring.

**Note**

<sup>(1)</sup> To order complete connector with hardware supplied unassembled, add suffix "UA" on end of hardware designation.



## Rack and Panel Connectors Side Mount

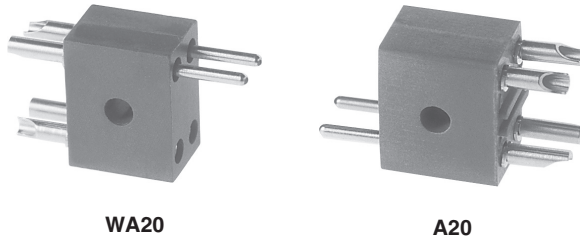

WA20

A20

### APPLICATIONS

Broad-limited only by those applications requiring physical, electrical and/or materials specifications exceeding those indicated.

### ELECTRICAL SPECIFICATIONS

**Current Rating:** 7.5 A

**Breakdown Voltage (Contact to Contact):**

At sea level: 2000 V<sub>RMS</sub>

At 70 000 feet [21 336 meters]: 500 V<sub>RMS</sub>

### FEATURES

- Body components available with any desired pin and socket combination
- Floating contacts
- Polarization accomplished by reversed pin and socket combination
- Model A20 has barriers for increased creepage distance
- Thru hole permits use of building block technique or flat mounting

### MATERIAL SPECIFICATIONS

**Standard Body:** Glass-filled diallyl phthalate per ASTM D 5948-96 green, flame retardant

**Pin Contacts:** Brass

**Socket Contacts:** Phosphor bronze

**Contact Plating:** Gold, 10 micro-inches

### PHYSICAL SPECIFICATIONS

**Minimum Creepage Path between Contacts:**

A20 = 0.08" [2.03 mm]; WA20 = 0.05" [1.27 mm]

**Minimum Air Space between Contacts:**

A20 = 0.08" [2.03 mm]; WA20 = 0.05" [1.27 mm]

**Contact, Center to Center:** A20 = 0.150" [3.81 mm];

WA20 = 0.125" [3.17 mm]

### DIMENSIONS in inches [millimeters]

A20P-CD

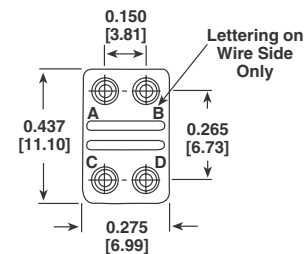
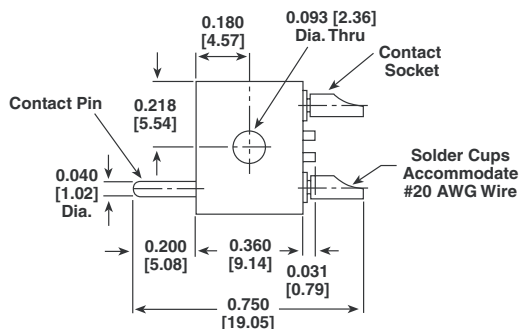

A20S-CD

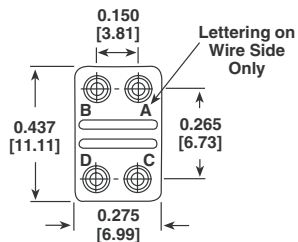
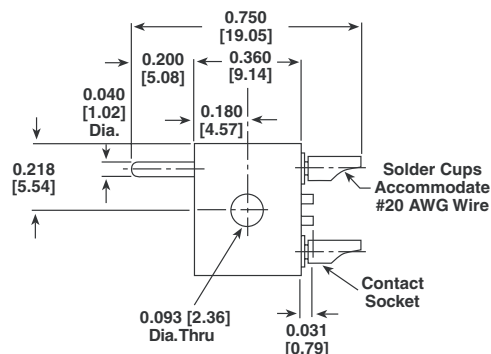



## DIMENSIONS in inches [millimeters]

WA20P-CD

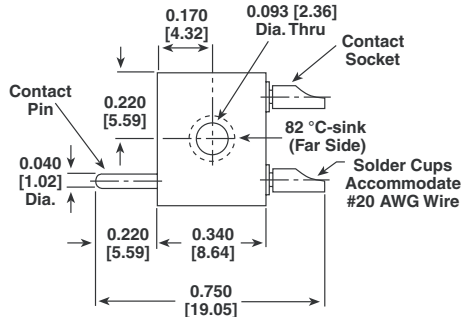

WA20S-CD

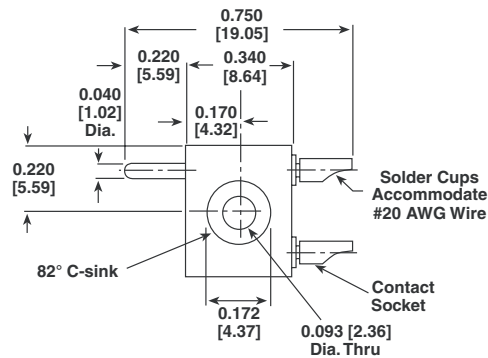

## ORDERING INFORMATION

**A20**  
**WA20**  
MODEL

Side Mount with 4 positions for #20 AWG contacts

**P**  
BODY STYLE

P - Designates pin style body.  
S - Designates socket style body.  
These designations are used to identify mating connectors, however, any combination of pin and socket contacts may be ordered in either style body. Therefore, when designators 3 and 4 are the same, a connector designated A20P or WA20P will mate with a connector designated A20S or WA20S.  
Example:  
A20P-CD mates with A20S-CD  
A20S-AB mates with A20P-CD

**AB**  
CONTACT LOCATION

Designates pin contact positions in an A20P or WA20P connector or socket contact positions in an A20S or WA20S connector (specify "A", "B", "C", "D" or any combination of the four)

**A**  
EMPTY CONTACT POSITIONS

Specify by contact identification letter (A, B, etc.) any contact positions which are to be left empty (omit, if none required)

**EXAMPLE 1:**

**A20P-CD or WA20P-CD** = Connector with pin contacts in positions "C" and "D" and socket contacts in positions "A" and "B"

**EXAMPLE 2:**

**A20S-CD or WA20S-CD** = Connector with socket contacts in positions "C" and "D" and pin contacts in positions "A" and "B" (would mate with Example 1 at left)

**EXAMPLE 3:**

**A20P-BC or WA20P-BC-A** = Connector with pin contacts in positions "B" and "C", socket contact in position "D" and no contact in position "A" (would mate with A20S-BC or WA20S-BC-A)

## Rack and Panel Connectors Side Mount

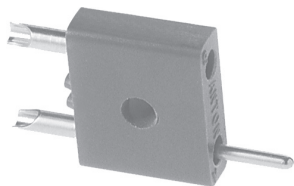
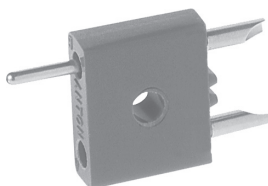
**G20P-A**

**G20S-A**

### APPLICATIONS

Broad - limited only by those applications requiring physical, electrical and/or materials specifications exceeding those indicated.

### ELECTRICAL SPECIFICATIONS

**Current Rating:** 7.5 A

**Breakdown Voltage (Contact to Contact):**

At sea level: 5000 V<sub>RMS</sub>

At 70 000 feet [21 336 meters]: 650 V<sub>RMS</sub>

### FEATURES

- Body components available with any desired pin and socket combination
- Contacts float in molding to aid in aligning and in withstanding vibration
- Polarization accomplished by reversed pin and socket combination
- Barriers for increased creepage distance
- Thru hold permits use of building block technique or flat mounting

### MATERIAL SPECIFICATIONS

**Standard Body:** Glass-filled diallyl phthalate per ASTM D 5948-96 green, flame retardant

**Pin Contacts:** Brass

**Socket Contacts:** Phosphor bronze

**Contact Plating:** Gold, 10 micro-inches

### PHYSICAL SPECIFICATIONS

**Minimum Creepage Path between Contacts:** 0.25" [6.35 mm]

**Minimum Air Space between Contacts:** 0.19" [4.76 mm]

**Maximum Wire Size:** #20 AWG

### DIMENSIONS in inches [millimeters]

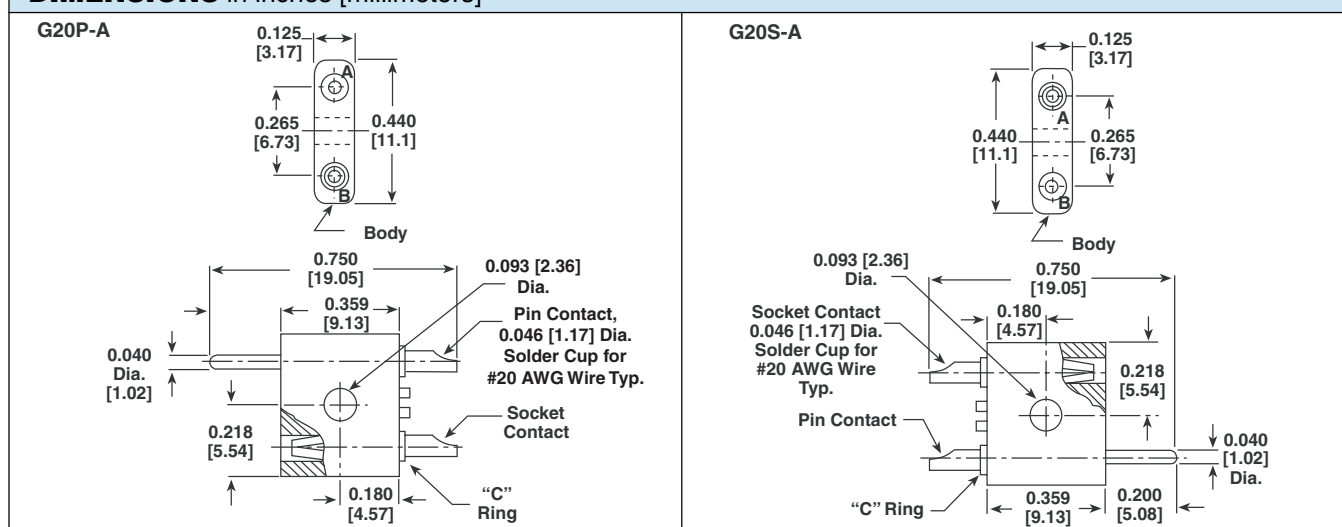

### ORDERING INFORMATION

G20 MODEL	S P BODY STYLE	AB B A CONTACT VARIATIONS
G20 - Side Mount with 2 positions for #20 AWG contacts	P - Pin style body. S - Socket style body. These designators are used to identify mating connectors. If designator 3 is the same, a connector designated G20P will mate with a connector designated G20S	Designates pin contact positions in a G20P connector or socket contact positions in a G20S connector
<b>EXAMPLE 1:</b> G20P-A = Connector with pin contact in position "A" and socket contact in position "B"	<b>EXAMPLE 2:</b> G20S-A = Connector with socket contact in position "A" and pin contact in position "B" (would mate with example 1 at left)	<b>EXAMPLE 3:</b> G20P-AB = Connector with pin contacts in both positions (would mate with G20S-AB)

## Rack and Panel Connectors Side Mount

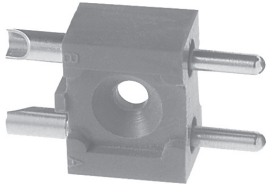

G16P-AB

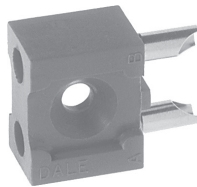

G16S-AB

### APPLICATIONS

Broad - limited only by those applications requiring physical, electrical and/or materials specifications exceeding those indicated.

### ELECTRICAL SPECIFICATIONS

**Current Rating:** 13 A

**Breakdown Voltage (Contact to Contact):**

At sea level: 4000 V<sub>RMS</sub>

At 70 000 feet [21 336 meters]: 550 V<sub>RMS</sub>

### FEATURES

- Body components available with any desired pin and socket combination
- Floating contacts aid in withstanding vibration
- Locking device permits secure mount of individual sections or complete component

### MATERIAL SPECIFICATIONS

**Standard Body:** Glass-filled diallyl phthalate per ASTM D 5948-96 green, flame retardant

**Pin Contacts:** Brass

**Socket Contacts:** Phosphor bronze

**Contact Plating:** Gold, 10 micro-inches

### PHYSICAL SPECIFICATIONS

**Minimum Creepage between Contacts:** 0.20" [5.16 mm]

**Minimum Air Space between Contacts:** 0.16" [3.97 mm]

**Maximum Wire Size:** #16 AWG

### DIMENSIONS in inches [millimeters]

G16P-AB

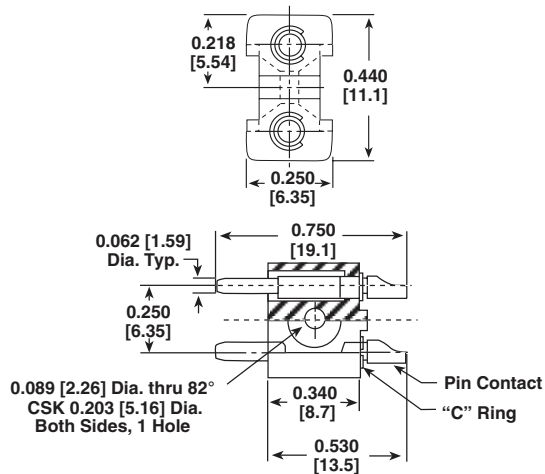

G16S-AB

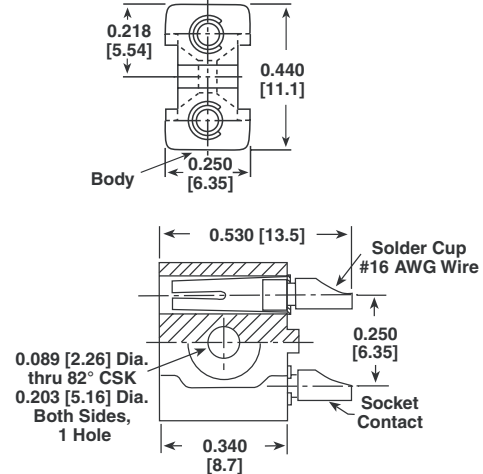

### ORDERING INFORMATION

**G16**  
MODEL

G16 - Side Mount with 2 positions for #16 AWG contacts

**EXAMPLE 1:**  
G16P-AB = Connector with pin contacts in position "A" and "B"

**S**  
**P**  
BODY STYLE

P - Pin style body. S - Socket style body. These designators are used to identify mating connectors. If designator 3 is the same, a connector designated G16P will mate with a connector designated G16S

**EXAMPLE 2:**  
G16S-AB = Connector with socket contacts in positions "A" and "B" (would mate with Example 1 at left)

**AB**  
**B**  
**A**  
CONTACT VARIATIONS

Designates pin contact positions in G16P connector and socket contact positions in a G16S connector

**EXAMPLE 3:**  
G16P-A = Connector with pin contact in position "A" and a socket contact in position "B"

**EXAMPLE 4:**  
G16S-A = Connector with socket contact in position "A" and a pin contact in position "B" (would mate with Example 3 at left)



# Cross Reference Guide

## Contents

<u>Company</u>	
Continental .....	24
Positronics .....	34
U.S. Components.....	41
Winchester .....	50

---

## Continental/Vishay Dale Rack and Panel Connectors - Microminiature, Subminiature, Miniature

CONTINENTAL	VISHAY DALE	CONTINENTAL	VISHAY DALE	CONTINENTAL	VISHAY DALE
3-500-6-5SGDS	CSMS20-5SL3	500-6-7SGDH	CSMS20-7027H	500-6-42SGDSL	CSMS20-42SK030
3-500-6-5SGDSK	CSMS20-5SK3	500-6-7SGDH-1	CSMS20-7027H1	500-6-42SGDW	CSMS20-42
3-500-6-5SGDSKH	CSMS20-5SK3H	500-6-7SGDS	CSMS20-7SL	500-6-50SGD	CSMS20-50027
3-500-6-5SGDSKH-1	CSMS20-5SK3H1	500-6-7SGDSK	CSMS20-7SK	500-6-50SGDH	CSMS20-50027H
3-500-6-5SGDSL	CSMS20-5SK3030	500-6-7SGDSKH	CSMS20-7SKH	500-6-50SGDH-1	CSMS20-50027H1
3-500-6-7SGDS	CSMS20-7SL3	500-6-7SGDSKH-1	CSMS20-7SKH1	500-6-50SGDS	CSMS20-50SL
3-500-6-7SGDSK	CSMS20-7SK3	500-6-7SGDSL	CSMS20-7SK030	500-6-50SGDSK	CSMS20-50SK
3-500-6-7SGDSKH	CSMS20-7SK3H	500-6-7SGDW	CSMS20-7	500-6-50SGDSKH	CSMS20-50SKH
3-500-6-7SGDSKH-1	CSMS20-7SK3H1	500-6-11SGD	CSMS20-11027	500-6-50SGDSKH-1	CSMS20-50SKH1
3-500-6-7SGDSL	CSMS20-7SK3030	500-6-11SGDH	CSMS20-11027H	500-6-50SGDSL	CSMS20-50SK030
3-500-6-11SGDS	CSMS20-11SL3	500-6-11SGDH-1	CSMS20-11027H1	500-6-50SGDW	CSMS20-50
3-500-6-11SGDSK	CSMS20-11SK3	500-6-11SGDS	CSMS20-11SL	500-6-75SGD	CSMS20-75027
3-500-6-11SGDSKH	CSMS20-11SK3H	500-6-11SGDSK	CSMS20-11SK	500-6-75SGDH	CSMS20-75027H
3-500-6-11SGDSKH-1	CSMS20-11SK3H1	500-6-11SGDSKH	CSMS20-11SKH	500-6-75SGDH-1	CSMS20-75027H1
3-500-6-11SGDSL	CSMS20-11SK3030	500-6-11SGDSKH-1	CSMS20-11SKH1	500-6-75SGDS	CSMS20-75SL
3-500-6-14SGDS	CSMS20-14SL3	500-6-11SGDSL	CSMS20-11SK030	500-6-75SGDSK	CSMS20-75SK
3-500-6-14SGDSK	CSMS20-14SK3	500-6-11SGDW	CSMS20-11	500-6-75SGDSKH	CSMS20-75SKH
3-500-6-14SGDSKH	CSMS20-14SK3H	500-6-14SGD	CSMS20-14027	500-6-75SGDSKH-1	CSMS20-75SKH1
3-500-6-14SGDSKH-1	CSMS20-14SK3H1	500-6-14SGDH	CSMS20-14027H	500-6-75SGDSL	CSMS20-75SK030
3-500-6-14SGDSL	CSMS20-14SK3030	500-6-14SGDH-1	CSMS20-14027H1	500-6-75SGDW	CSMS20-75
3-500-6-20SGDS	CSMS20-20SL3	500-6-14SGDS	CSMS20-14SL	3SM5-20PDGDS	SMDP20-5SL3
3-500-6-20SGDSK	CSMS20-20SK3	500-6-14SGDSK	CSMS20-14SK	3SM5-20PDGDSK	SMDP20-5SK3
3-500-6-20SGDSKH	CSMS20-20SK3H	500-6-14SGDSKH	CSMS20-14SKH	3SM5-20PDGDSKH	SMDP20-5SK3H
3-500-6-20SGDSKH-1	CSMS20-20SK3H1	500-6-14SGDSKH-1	CSMS20-14SKH1	3SM5-20PDGDSKH1	SMDP20-5SK3H1
3-500-6-20SGDSL	CSMS20-20SK3030	500-6-14SGDSL	CSMS20-14SK030	3SM5-20PGDSL	SMDP20-5SK3030
3-500-6-26SGDS	CSMS20-26SL3	500-6-14SGDW	CSMS20-14	3SM5-20PGDSL	SMP20-5SL3
3-500-6-26SGDSK	CSMS20-26SK3	500-6-20SGD	CSMS20-20027	3SM5-20PGDSK	SMP20-5SK3
3-500-6-26SGDSKH	CSMS20-26SK3H	500-6-20SGDH	CSMS20-20027H	3SM5-20PGDSKH	SMP20-5SK3H
3-500-6-26SGDSKH-1	CSMS20-26SK3H1	500-6-20SGDH-1	CSMS20-20027H1	3SM5-20PGDSKH-1	SMP20-5SK3H1
3-500-6-26SGDSL	CSMS20-26SK3030	500-6-20SGDS	CSMS20-20SL	3SM5-20PGDSL	SMP20-5SK3030
3-500-6-34SGDS	CSMS20-34SL3	500-6-20SGDSK	CSMS20-20SK	3SM5-20SDGDS	SMDS20-5SL3
3-500-6-34SGDSK	CSMS20-34SK3	500-6-20SGDSKH	CSMS20-20SKH	3SM5-20SDGDSK	SMDS20-5SK3
3-500-6-34SGDSKH	CSMS20-34SK3H	500-6-20SGDSKH-1	CSMS20-20SKH1	3SM5-20SDGDSKH	SMDS20-5SK3H
3-500-6-34SGDSKH-1	CSMS20-34SK3H1	500-6-20SGDSL	CSMS20-20SK030	3SM5-20SDGDSKH-1	SMDS20-5SK3H1
3-500-6-34SGDSL	CSMS20-34SK3030	500-6-20SGDW	CSMS20-20	3SM5-20SDGDSL	SMDS20-5SK3030
3-500-6-42SGDS	CSMS20-42SL3	500-6-26SGD	CSMS20-26027	3SM5-20SDGDS	SMS20-5SL3
3-500-6-42SGDSK	CSMS20-42SK3	500-6-26SGDH	CSMS20-26027H	3SM5-20SDGDSK	SMS20-5SK3
3-500-6-42SGDSKH	CSMS20-42SK3H	500-6-26SGDH-1	CSMS20-26027H1	3SM5-20SDGDSKH	SMS20-5SK3H
3-500-6-42SGDSKH-1	CSMS20-42SK3H1	500-6-26SGDS	CSMS20-26SL	3SM5-20SDGDSKH-1	SMS20-5SK3H1
3-500-6-42SGDSL	CSMS20-42SK3030	500-6-26SGDSK	CSMS20-26SK	3SM5-20SGDSL	SMS20-5SK3030
3-500-6-50SGDS	CSMS20-50SL3	500-6-26SGDSKH	CSMS20-26SKH	3SM7-20PDGDS	SMDP20-7SL3
3-500-6-50SGDSK	CSMS20-50SK3	500-6-26SGDSKH-1	CSMS20-26SKH1	3SM7-20PDGDSK	SMDP20-7SK3
3-500-6-50SGDSKH	CSMS20-50SK3H	500-6-26SGDSL	CSMS20-26SK030	3SM7-20PDGDSKH	SMDP20-7SK3H
3-500-6-50SGDSKH-1	CSMS20-50SK3H1	500-6-26SGDW	CSMS20-26	3SM7-20PDGDSKH-1	SMDP20-7SK3H1
3-500-6-50SGDSL	CSMS20-50SK3030	500-6-34SGD	CSMS20-34027	3SM7-20PDGDSL	SMDP20-7SK3030
3-500-6-75SGDS	CSMS20-75SL3	500-6-34SGDH	CSMS20-34027H	3SM7-20PGDS	SMP20-7SL3
3-500-6-75SGDSK	CSMS20-75SK3	500-6-34SGDH-1	CSMS20-34027H1	3SM7-20PGDSK	SMP20-7SK3
3-500-6-75SGDSKH	CSMS20-75SK3H	500-6-34SGDS	CSMS20-34SL	3SM7-20PGDSKH	SMP20-7SK3H
3-500-6-75SGDSKH-1	CSMS20-75SK3H1	500-6-34SGDSK	CSMS20-34SK	3SM7-20PGDSKH-1	SMP20-7SK3H1
3-500-6-75SGDSL	CSMS20-75SK3030	500-6-34SGDSKH	CSMS20-34SKH	3SM7-20PGDSL	SMP20-7SK3030
500-6-5SGD	CSMS20-5027	500-6-34SGDSKH-1	CSMS20-34SKH1	3SM7-20SDGDS	SMDS20-7SL3
500-6-5SGDH	CSMS20-5027H	500-6-34SGDSL	CSMS20-34SK030	3SM7-20SDGDSK	SMDS20-7SK3
500-6-5SGDH-1	CSMS20-5027H1	500-6-34SGDW	CSMS20-34	3SM7-20SDGDSKH	SMDS20-7SK3H
500-6-5SGDS	CSMS20-5SL	500-6-42SGD	CSMS20-42027	3SM7-20SDGDSKH-1	SMDS20-7SK3H1
500-6-5SGDSK	CSMS20-5SK	500-6-42SGDH	CSMS20-42027H	3SM7-20SDGDSL	SMDS20-7SK3030
500-6-5SGDSKH	CSMS20-5SKH	500-6-42SGDH-1	CSMS20-42027H1	3SM7-20SDGDS	SMS20-7SL3
500-6-5SGDSKH-1	CSMS20-5SKH1	500-6-42SGDS	CSMS20-42SL	3SM7-20SDGDSK	SMS20-7SK3
500-6-5SGDSL	CSMS20-5SK030	500-6-42SGDSK	CSMS20-42SK	3SM7-20SDGDSKH	SMS20-7SK3H
500-6-5SGDW	CSMS20-5	500-6-42SGDSKH	CSMS20-42SKH	3SM7-20SDGDSKH-1	SMS20-7SK3H1
500-6-7SGD	CSMS20-7027	500-6-42SGDSKH-1	CSMS20-42SKH1	3SM7-20SGDSL	SMS20-7SK3030



# Cross Reference - Continental

Continental/Vishay Dale Rack and Panel Connectors -  
Microminiature, Subminiature, Miniature

Vishay Dale

CONTINENTAL	VISHAY DALE	CONTINENTAL	VISHAY DALE	CONTINENTAL	VISHAY DALE
3SM11-20PDGDS	SMDP20-11SL3	3SM26-20PDGDS	SMDP20-26SL3	3SM50-20PDGDS	SMDP20-50SL3
3SM11-20PDGDSK	SMDP20-11SK3	3SM26-20PDGDSK	SMDP20-26SK3	3SM50-20PDGDSK	SMDP20-50SK3
3SM11-20PDGDSKH	SMDP20-11SK3H	3SM26-20PDGDSKH	SMDP20-26SK3H	3SM50-20PDGDSKH	SMDP20-50SK3H
3SM11-20PDGDSKH-1	SMDP20-11SK3H1	3SM26-20PDGDSKH-1	SMDP20-26SK3H1	3SM50-20PDGDSKH-1	SMDP20-50SK3H1
3SM11-20PDGDSL	SMDP20-11SK3030	3SM26-20PDGDSL	SMDP20-26SK3030	3SM50-20PDGDSL	SMDP20-50SK3030
3SM11-20PGDS	SMP20-11SL3	3SM26-20PGDS	SMP20-26SL3	3SM50-20PGDS	SMP20-50SL3
3SM11-20PGDSK	SMP20-11SK3	3SM26-20PGDSK	SMP20-26SK3	3SM50-20PGDSK	SMP20-50SK3
3SM11-20PGDSKH	SMP20-11SK3H	3SM26-20PGDSKH	SMP20-26SK3H	3SM50-20PGDSKH	SMP20-50SK3H
3SM11-20PGDSKH-1	SMP20-11SK3H1	3SM26-20PGDSKH-1	SMP20-26SK3H1	3SM50-20PGDSKH-1	SMP20-50SK3H1
3SM11-20PGDSL	SMP20-11SK3030	3SM26-20PGDSL	SMP20-26SK3030	3SM50-20PGDSL	SMP20-50SK3030
3SM11-20SDGDS	SMD20-11SL3	3SM26-20SDGDS	SMD20-26SL3	3SM50-20SDGDS	SMD20-50SL3
3SM11-20SDGDK	SMD20-11SK3	3SM26-20SDGDK	SMD20-26SK3	3SM50-20SDGDK	SMD20-50SK3
3SM11-20SDGDSKH	SMD20-11SK3H	3SM26-20SDGDSKH	SMD20-26SK3H	3SM50-20SDGDSKH	SMD20-50SK3H
3SM11-20SDGDSKH-1	SMD20-11SK3H1	3SM26-20SDGDSKH-1	SMD20-26SK3H1	3SM50-20SDGDSKH-1	SMD20-50SK3H1
3SM11-20SDGDSL	SMD20-11SK3030	3SM26-20SDGDSL	SMD20-26SK3030	3SM50-20SDGDSL	SMD20-50SK3030
3SM11-20SGDS	SMS20-11SL3	3SM26-20SGDS	SMS20-26SL3	3SM50-20SGDS	SMS20-50SL3
3SM11-20SGDSK	SMS20-11SK3	3SM26-20SGDSK	SMS20-26SK3	3SM50-20SGDSK	SMS20-50SK3
3SM11-20SGDSKH	SMS20-11SK3H	3SM26-20SGDSKH	SMS20-26SK3H	3SM50-20SGDSKH	SMS20-50SK3H
3SM11-20SGDSKH-1	SMS20-11SK3H1	3SM26-20SGDSKH-1	SMS20-26SK3H1	3SM50-20SGDSKH-1	SMS20-50SK3H1
3SM11-20SGDSL	SMS20-11SK3030	3SM26-20SGDSL	SMS20-26SK3030	3SM50-20SGDSL	SMS20-50SK3030
3SM14-20PDGDS	SMDP20-14SL3	3SM34-20PDGDS	SMDP20-34SL3	3SM75-20PDGDS	SMDP20-75SL3
3SM14-20PDGDSK	SMDP20-14SK3	3SM34-20PDGDSK	SMDP20-34SK3	3SM75-20PDGDSK	SMDP20-75SK3
3SM14-20PDGDSKH	SMDP20-14SK3H	3SM34-20PDGDSKH	SMDP20-34SK3H	3SM75-20PDGDSKH	SMDP20-75SK3H
3SM14-20PDGDSKH-1	SMDP20-14SK3H1	3SM34-20PDGDSKH-1	SMDP20-34SK3H1	3SM75-20PDGDSKH-1	SMDP20-75SK3H1
3SM14-20PDGDSL	SMDP20-14SK3030	3SM34-20PDGDSL	SMDP20-34SK3030	3SM75-20PDGDSL	SMDP20-75SK3030
3SM14-20PGDS	SMP20-14SL3	3SM34-20PGDS	SMP20-34SL3	3SM75-20PGDS	SMP20-75SL3
3SM14-20PGDSK	SMP20-14SK3	3SM34-20PGDSK	SMP20-34SK3	3SM75-20PGDSK	SMP20-75SK3
3SM14-20PGDSKH	SMP20-14SK3H	3SM34-20PGDSKH	SMP20-34SK3H	3SM75-20PGDSKH	SMP20-75SK3H
3SM14-20PGDSKH-1	SMP20-14SK3H1	3SM34-20PGDSKH-1	SMP20-34SK3H1	3SM75-20PGDSKH-1	SMP20-75SK3H1
3SM14-20PGDSL	SMP20-14SK3030	3SM34-20PGDSL	SMP20-34SK3030	3SM75-20PGDSL	SMP20-75SK3030
3SM14-20SDGDS	SMD20-14SL3	3SM34-20SDGDS	SMD20-34SL3	3SM75-20SDGDS	SMD20-75SL3
3SM14-20SDGDK	SMD20-14SK3	3SM34-20SDGDK	SMD20-34SK3	3SM75-20SDGDK	SMD20-75SK3
3SM14-20SDGDSKH	SMD20-14SK3H	3SM34-20SDGDSKH	SMD20-34SK3H	3SM75-20SDGDSKH	SMD20-75SK3H
3SM14-20SDGDSKH-1	SMD20-14SK3H1	3SM34-20SDGDSKH-1	SMD20-34SK3H1	3SM75-20SDGDSKH-1	SMD20-75SK3H1
3SM14-20SDGDSL	SMD20-14SK3030	3SM34-20SDGDSL	SMD20-34SK3030	3SM75-20SDGDSL	SMD20-75SK3030
3SM14-20SGDS	SMS20-14SL3	3SM34-20SGDS	SMS20-34SL3	3SM75-20SGDS	SMS20-75SL3
3SM14-20SGDSK	SMS20-14SK3	3SM34-20SGDSK	SMS20-34SK3	3SM75-20SGDSK	SMS20-75SK3
3SM14-20SGDSKH	SMS20-14SK3H	3SM34-20SGDSKH	SMS20-34SK3H	3SM75-20SGDSKH	SMS20-75SK3H
3SM14-20SGDSKH-1	SMS20-14SK3H1	3SM34-20SGDSKH-1	SMS20-34SK3H1	3SM75-20SGDSKH-1	SMS20-75SK3H1
3SM14-20SGDSL	SMS20-14SK3030	3SM34-20SGDSL	SMS20-34SK3030	3SM75-20SGDSL	SMS20-75SK3030
3SM20-20PDGDS	SMDP20-20SL3	3SM42-20PDGDS	SMDP20-42SL3	7-20P	MP20-7
3SM20-20PDGDSK	SMDP20-20SK3	3SM42-20PDGDSK	SMDP20-42SK3	7-20PS	MP20-7SL
3SM20-20PDGDSKH	SMDP20-20SK3H	3SM42-20PDGDSKH	SMDP20-42SK3H	7-20PSK	MP20-7SK
3SM20-20PDGDSKH-1	SMDP20-20SK3H1	3SM42-20PDGDSKH-1	SMDP20-42SK3H1	7-20PW	MP20-7W
3SM20-20PDGDSL	SMDP20-20SK3030	3SM42-20PDGDSL	SMDP20-42SK3030	7-20S	MS20-7
3SM20-20PGDS	SMP20-20SL3	3SM42-20PGDS	SMP20-42SL3	7-20SS	MS20-7SL
3SM20-20PGDSK	SMP20-20SK3	3SM42-20PGDSK	SMP20-42SK3	7-20SSK	MS20-7SK
3SM20-20PGDSKH	SMP20-20SK3H	3SM42-20PGDSKH	SMP20-42SK3H	7-20SW	MS20-7W
3SM20-20PGDSKH-1	SMP20-20SK3H1	3SM42-20PGDSKH-1	SMP20-42SK3H1	9-20P	MP20-9
3SM20-20PGDSL	SMP20-20SK3030	3SM42-20PGDSL	SMP20-42SK3030	9-20PS	MP20-9SL
3SM20-20SDGDS	SMD20-20SL3	3SM42-20SDGDS	SMD20-42SL3	9-20PSK	MP20-9SK
3SM20-20SDGDK	SMD20-20SK3	3SM42-20SDGDK	SMD20-42SK3	9-20PW	MP20-9W
3SM20-20SDGDSKH	SMD20-20SK3H	3SM42-20SDGDSKH	SMD20-42SK3H	9-20S	MS20-9
3SM20-20SDGDSKH-1	SMD20-20SK3H1	3SM42-20SDGDSKH-1	SMD20-42SK3H1	9-20SS	MS20-9SL
3SM20-20SDGDSL	SMD20-20SK3030	3SM42-20SDGDSL	SMD20-42SK3030	9-20SSK	MS20-9SK
3SM20-20SGDS	SMS20-20SL3	3SM42-20SGDS	SMS20-42SL3	9-20SW	MS20-9W
3SM20-20SGDSK	SMS20-20SK3	3SM42-20SGDSK	SMS20-42SK3	14-20P	MP20-14
3SM20-20SGDSKH	SMS20-20SK3H	3SM42-20SGDSKH	SMS20-42SK3H	14-20PS	MP20-14SL
3SM20-20SGDSKH-1	SMS20-20SK3H1	3SM42-20SGDSKH-1	SMS20-42SK3H1	14-20PSK	MP20-14SK
3SM20-20SGDSL	SMS20-20SK3030	3SM42-20SGDSL	SMS20-42SK3030	14-20PW	MP20-14W



# Cross Reference - Continental



Vishay Dale

Continental/Vishay Dale Rack and Panel Connectors -  
Microminiature, Subminiature, Miniature

CONTINENTAL	VISHAY DALE	CONTINENTAL	VISHAY DALE	CONTINENTAL	VISHAY DALE
14-20S	MS20-14	CMM-22SDGD	CMMD1S22-026	CMM9-22SGDSK	CMMS22-9SK2
14-20SS	MS20-14SL	CMM-22SDGDH	CMMD1S22-026H	CMM9-22SGDSKH	CMMS22-9SK2H
14-20SSK	MS20-14SK	CMM-22SDGDS	CMMD1S22-SL2	CMM9-22SGDSL	CMMS22-9SK2030
14-20SW	MS20-14W	CMM-22SDGDS-25	CMMD1S22-SL2L	CMM9-22SGDW	CMMS22-9
18-20P	MP20-18	CMM-22SDGDSK	CMMD1S22-SK2	CMM11-22SDGD	CMMD1S22-11026
18-20PS	MP20-18SL	CMM-22SDGDSKH	CMMD1S22-SK2H	CMM11-22SDGDH	CMMD1S22-11026H
18-20PSK	MP20-18SK	CMM-22SDGDSL	CMMD1S22-SK2030	CMM11-22SDGDS	CMMD1S22-11SL2
18-20PW	MP20-18W	CMM-22SDGDW	CMMD1S22-S	CMM11-22SDGDS-25	CMMD1S22-11SL2L
18-20S	MS20-18	CMM-22SGD	CMMS22-026	CMM11-22SDGDSK	CMMD1S22-11SK2
18-20SS	MS20-18SL	CMM-22SGDH	CMMS22-026H	CMM11-22SDGDSKH	CMMD1S22-11SK2H
18-20SSK	MS20-18SK	CMM-22SGDS	CMMS22-SL2	CMM11-22SDGDSL	CMMD1S22-11SK2030
18-20SW	MS20-18W	CMM-22SGDS-25	CMMS22-SL2L	CMM11-22SDGDW	CMMD1S22-11
20-20P	MP20-20	CMM-22SGDSK	CMMS22-SK2	CMM11-22SGD	CMMS22-11026
20-20PS	MP20-20SL	CMM-22SGDSKH	CMMS22-SK2H	CMM11-22SGDH	CMMS22-11026H
20-20PSK	MP20-20SK	CMM-22SGDSL	CMMS22-SK2030	CMM11-22SGDS	CMMS22-11SL2
20-20PW	MP20-20W	CMM-22SGDW	CMMS22-S	CMM11-22SGDS-25	CMMS22-11SL2L
20-20S	MS20-20	CMM5-22SDGD	CMMD1S22-5026	CMM11-22SGDSK	CMMS22-11SK2
20-20SS	MS20-20SL	CMM5-22SDGDH	CMMD1S22-5026H	CMM11-22SGDSKH	CMMS22-11SK2H
20-20SSK	MS20-20SK	CMM5-22SDGDS	CMMD1S22-5SL2	CMM11-22SGDSL	CMMS22-11SK2030
20-20SW	MS20-20W	CMM5-22SDGDS-25	CMMD1S22-5SL2L	CMM11-22SGDW	CMMS22-11
26-20P	MP20-26	CMM5-22SDGDSK	CMMD1S22-5SK2	CMM14-22SDGD	CMMD1S22-14026
26-20PS	MP20-26SL	CMM5-22SDGDSKH	CMMD1S22-5SK2H	CMM14-22SDGDH	CMMD1S22-14026H
26-20PSK	MP20-26SK	CMM5-22SDGDSL	CMMD1S22-5SK2030	CMM14-22SDGDS	CMMD1S22-14SL2
26-20PW	MP20-26W	CMM5-22SDGDW	CMMD1S22-5	CMM14-22SDGDS-25	CMMD1S22-14SL2L
26-20S	MS20-26	CMM5-22SGD	CMMS22-5026	CMM14-22SDGDSK	CMMD1S22-14SK2
26-20SS	MS20-26SL	CMM5-22SGDH	CMMS22-5026H	CMM14-22SDGDSKH	CMMD1S22-14SK2H
26-20SSK	MS20-26SK	CMM5-22SGDS	CMMS22-5SL2	CMM14-22SDGDSL	CMMD1S22-14SK2030
26-20SW	MS20-26W	CMM5-22SGDS-25	CMMS22-5SL2L	CMM14-22SDGDW	CMMD1S22-14
34-20P	MP20-34	CMM5-22SGDSK	CMMS22-5SK2	CMM14-22SGD	CMMS22-14026
34-20PS	MP20-34SL	CMM5-22SGDSKH	CMMS22-5SK2H	CMM14-22SGDH	CMMS22-14026H
34-20PSK	MP20-34SK	CMM5-22SGDSL	CMMS22-5SK2030	CMM14-22SGDS	CMMS22-14SL2
34-20PW	MP20-34W	CMM5-22SGDW	CMMS22-5	CMM14-22SGDS-25	CMMS22-14SL2L
34-20S	MS20-34	CMM7-22SDGD	CMMD1S22-7026	CMM14-22SGDSK	CMMS22-14SK2
34-20SS	MS20-34SL	CMM7-22SDGDH	CMMD1S22-7026H	CMM14-22SGDSKH	CMMS22-14SK2H
34-20SSK	MS20-34SK	CMM7-22SDGDS	CMMD1S22-7SL2	CMM14-22SGDSL	CMMS22-14SK2030
34-20SW	MS20-34W	CMM7-22SDGDS-25	CMMD1S22-7SL2L	CMM14-22SGDW	CMMS22-14
41-20P	MP20-41	CMM7-22SDGDSK	CMMD1S22-7SK2	CMM18-22SDGD	CMMD1S22-18026
41-20PS	MP20-41SL	CMM7-22SDGDSKH	CMMD1S22-7SK2H	CMM18-22SDGDH	CMMD1S22-18026H
41-20PSK	MP20-41SK	CMM7-22SDGDSL	CMMD1S22-7SK2030	CMM18-22SDGDS	CMMD1S22-18SL2
41-20PW	MP20-41W	CMM7-22SDGDW	CMMD1S22-7	CMM18-22SDGDS-25	CMMD1S22-18SL2L
41-20S	MS20-41	CMM7-22SGD	CMMS22-7026	CMM18-22SDGDSK	CMMD1S22-18SK2
41-20SS	MS20-41SL	CMM7-22SGDH	CMMS22-7026H	CMM18-22SDGDSKH	CMMD1S22-18SK2H
41-20SSK	MS20-41SK	CMM7-22SGDS	CMMS22-7SL2	CMM18-22SDGDSL	CMMD1S22-18SK2030
41-20SW	MS20-41W	CMM7-22SGDS-25	CMMS22-7SL2L	CMM18-22SDGDW	CMMD1S22-18
50-20P	MP20-50	CMM7-22SGDSK	CMMS22-7SK2	CMM18-22SGD	CMMS22-18026
50-20PS	MP20-50SL	CMM7-22SGDSKH	CMMS22-7SK2H	CMM18-22SGDH	CMMS22-18026H
50-20PSK	MP20-50SK	CMM7-22SGDSL	CMMS22-7SK2030	CMM18-22SGDS	CMMS22-18SL2
50-20PW	MP20-50W	CMM7-22SGDW	CMMS22-7	CMM18-22SGDS-25	CMMS22-18SL2L
50-20S	MS20-50	CMM9-22SDGD	CMMD1S22-9026	CMM18-22SGDSK	CMMS22-18SK2
50-20SS	MS20-50SL	CMM9-22SDGDH	CMMD1S22-9026H	CMM18-22SGDSKH	CMMS22-18SK2H
50-20SSK	MS20-50SK	CMM9-22SDGDS	CMMD1S22-9SL2	CMM18-22SGDSL	CMMS22-18SK2030
50-20SW	MS20-50W	CMM9-22SDGDS-25	CMMD1S22-9SL2L	CMM18-22SGDW	CMMS22-18
75-20P	MP20-75	CMM9-22SDGDSK	CMMD1S22-9SK2	CMM20-22SDGD	CMMD1S22-20026
75-20PS	MP20-75SL	CMM9-22SDGDSKH	CMMD1S22-9SK2H	CMM20-22SDGDH	CMMD1S22-20026H
75-20PSK	MP20-75SK	CMM9-22SDGDSL	CMMD1S22-9SK2030	CMM20-22SDGDS	CMMD1S22-20SL2
75-20PW	MP20-75W	CMM9-22SDGDW	CMMD1S22-9	CMM20-22SDGDS-25	CMMD1S22-20SL2L
75-20S	MS20-75	CMM9-22SGD	CMMS22-9026	CMM20-22SDGDSK	CMMD1S22-20SK2
75-20SS	MS20-75SL	CMM9-22SGDH	CMMS22-9026H	CMM20-22SDGDSKH	CMMD1S22-20SK2H
75-20SSK	MS20-75SK	CMM9-22SGDS	CMMS22-9SL2	CMM20-22SDGDSL	CMMD1S22-20SK2030
75-20SW	MS20-75W	CMM9-22SGDS-25	CMMS22-9SL2L	CMM20-22SDGDW	CMMD1S22-20



# Cross Reference - Continental

Continental/Vishay Dale Rack and Panel Connectors -  
Microminiature, Subminiature, Miniature

Vishay Dale

CONTINENTAL	VISHAY DALE	CONTINENTAL	VISHAY DALE	CONTINENTAL	VISHAY DALE
CMM20-22SGD	CMMS22-20026	CMM44-22SDGDSK	CMMD1S22-44SK2	MM5-24PDGD	MMD1P24-5026
CMM20-22SGDH	CMMS22-20026H	CMM44-22SDGDSKH	CMMD1S22-44SK2H	MM5-24PDGDH	MMD1P24-5026H
CMM20-22SGDS	CMMS22-20SL2	CMM44-22SDGDSL	CMMD1S22-44SK2030	MM5-24PDGDS	MMD1P24-5SL2
CMM20-22SGDS-25	CMMS22-20SL2L	CMM44-22SDGDW	CMMD1S22-44	MM5-24PDGDS-25	MMD1P24-5SL2L
CMM20-22SGDSK	CMMS22-20SK2	CMM44-22SGD	CMMS22-44026	MM5-24PDGDSK	MMD1P24-5SK2
CMM20-22SGDSKH	CMMS22-20SK2H	CMM44-22SGDH	CMMS22-44026H	MM5-24PDGDSKH	MMD1P24-5SK2H
CMM20-22SGDSL	CMMS22-20SK2030	CMM44-22SGDS	CMMS22-44SL2	MM5-24PDGDSL	MMD1P24-5SK2030
CMM20-22SGDW	CMMS22-20	CMM44-22SGDS-25	CMMS22-44SL2L	MM5-24PDGDW	MMD1P24-5
CMM26-22SDGD	CMMD1S22-26026	CMM44-22SGDSK	CMMS22-44SK2	MM5-24PGD	MMP24-5026
CMM26-22SDGDH	CMMD1S22-26026H	CMM44-22SGDSKH	CMMS22-44SK2H	MM5-24PGDH	MMP24-5026H
CMM26-22SDGDS	CMMD1S22-26SL2	CMM44-22SGDSL	CMMS22-44SK2030	MM5-24PGDS	MMP24-5SL2
CMM26-22SDGDS-25	CMMD1S22-26SL2L	CMM44-22SGDW	CMMS22-44	MM5-24PGDS-25	MMP24-5SL2L
CMM26-22SDGDSK	CMMD1S22-26SK2	CMM50-22SDGD	CMMD1S22-C50026	MM5-24PGDSK	MMP24-5SK2
CMM26-22SDGDSKH	CMMD1S22-26SK2H	CMM50-22SDGDH	CMMD1S22-C50026H	MM5-24PGDSKH	MMP24-5SK2H
CMM26-22SDGDSL	CMMD1S22-26SK2030	CMM50-22SDGDS	CMMD1S22-C50SL2	MM5-24PGDSL	MMP24-5SK2030
CMM26-22SDGDW	CMMD1S22-26	CMM50-22SDGDS-25	CMMD1S22-C50SL2L	MM5-24PGDW	MMP24-5
CMM26-22SGD	CMMS22-26026	CMM50-22SDGDSK	CMMD1S22-C50SK2	MM5-24SDGD	MMD1S24-5026
CMM26-22SGDH	CMMS22-26026H	CMM50-22SDGDSKH	CMMD1S22-C50SK2H	MM5-24SDGDH	MMD1S24-5026H
CMM26-22SGDS	CMMS22-26SL2	CMM50-22SDGDSL	CMMD1S22-C50SK2030	MM5-24SDGDS	MMD1S24-5SL2
CMM26-22SGDS-25	CMMS22-26SL2L	CMM50-22SDGDW	CMMD1S22-C50	MM5-24SDGDS-25	MMD1S24-5SL2L
CMM26-22SGDSK	CMMS22-26SK2	CMM50-22SGD	CMMS22-C50026	MM5-24SDGDSK	MMD1S24-5SK2
CMM26-22SGDSKH	CMMS22-26SK2H	CMM50-22SGDH	CMMS22-C50026H	MM5-24SDGDSKH	MMD1S24-5SK2H
CMM26-22SGDSL	CMMS22-26SK2030	CMM50-22SGDS	CMMS22-C50SL2	MM5-24SDGDSL	MMD1S24-5SK2030
CMM26-22SGDW	CMMS22-26	CMM50-22SGDS-25	CMMS22-C50SL2L	MM5-24SDGDW	MMD1S24-5
CMM29-22SDGD	CMMD1S22-29026	CMM50-22SGDSK	CMMS22-C50SK2	MM5-24SGD	MMS24-5026
CMM29-22SDGDH	CMMD1S22-29026H	CMM50-22SGDSKH	CMMS22-C50SK2H	MM5-24SGDH	MMS24-5026H
CMM29-22SDGDS	CMMD1S22-29SL2	CMM50-22SGDSL	CMMS22-C50SK2030	MM5-24SGDS	MMS24-5SL2
CMM29-22SDGDS-25	CMMD1S22-29SL2L	CMM50-22SGDW	CMMS22-C50	MM5-24SGDS-25	MMS24-5SL2L
CMM29-22SDGDSK	CMMD1S22-29SK2	MM5-22PDGD	MMD1P22-5026	MM5-24SGDSK	MMS24-5SK2
CMM29-22SDGDSKH	CMMD1S22-29SK2H	MM5-22PDGDH	MMD1P22-5026H	MM5-24SGDSKH	MMS24-5SK2H
CMM29-22SDGDSL	CMMD1S22-29SK2030	MM5-22PDGDS	MMD1P22-5SL2	MM5-24SGDSL	MMS24-5SK2030
CMM29-22SDGDW	CMMD1S22-29	MM5-22PDGDS-25	MMD1P22-5SL2L	MM5-24SGDW	MMS24-5
CMM29-22SGD	CMMS22-29026	MM5-22PDGDGSK	MMD1P22-5SK2	MM7-22PDGD	MMD1P22-7026
CMM29-22SGDH	CMMS22-29026H	MM5-22PDGDGSKH	MMD1P22-5SK2H	MM7-22PDGDH	MMD1P22-7026H
CMM29-22SGDS	CMMS22-29SL2	MM5-22PDGDSL	MMD1P22-5SK2030	MM7-22PDGDS	MMD1P22-7SL2
CMM29-22SGDS-25	CMMS22-29SL2L	MM5-22PDGDW	MMD1P22-5	MM7-22PDGDS-25	MMD1P22-7SL2L
CMM29-22SGDSK	CMMS22-29SK2	MM5-22PGD	MMP22-5026	MM7-22PDGDSK	MMD1P22-7SK2
CMM29-22SGDSKH	CMMS22-29SK2H	MM5-22PGDH	MMP22-5026H	MM7-22PDGDSKH	MMD1P22-7SK2H
CMM29-22SGDSL	CMMS22-29SK2030	MM5-22PGDS	MMP22-5SL2	MM7-22PDGDSL	MMD1P22-7SK2030
CMM29-22SGDW	CMMS22-29	MM5-22PGDS-25	MMP22-5SL2L	MM7-22PDGDW	MMD1P22-7
CMM34-22SDGD	CMMD1S22-34026	MM5-22PGDSK	MMP22-5SK2	MM7-22PGD	MMP22-7026
CMM34-22SDGDH	CMMD1S22-34026H	MM5-22PGDSKH	MMP22-5SK2H	MM7-22PGDH	MMP22-7026H
CMM34-22SDGDS	CMMD1S22-34SL2	MM5-22PGDSL	MMP22-5SK2030	MM7-22PGDS	MMP22-7SL2
CMM34-22SDGDS-25	CMMD1S22-34SL2L	MM5-22PGDW	MMP22-5	MM7-22PGDS-25	MMP22-7SL2L
CMM34-22SDGDSK	CMMD1S22-34SK2	MM5-22SDGD	MMD1S22-5026	MM7-22PGDSK	MMP22-7SK2
CMM34-22SDGDSKH	CMMD1S22-34SK2H	MM5-22SDGDH	MMD1S22-5026H	MM7-22PGDSKH	MMP22-7SK2H
CMM34-22SDGDSL	CMMD1S22-34SK2030	MM5-22SDGDS	MMD1S22-5SL2	MM7-22PGDSL	MMP22-7SK2030
CMM34-22SDGDW	CMMD1S22-34	MM5-22SDGDS-25	MMD1S22-5SL2L	MM7-22PGDW	MMP22-7
CMM34-22SGD	CMMS22-34026	MM5-22SDGDSK	MMD1S22-5SK2	MM7-22SDGD	MMD1S22-7026
CMM34-22SGDH	CMMS22-34026H	MM5-22SDGDSKH	MMD1S22-5SK2H	MM7-22SDGDH	MMD1S22-7026H
CMM34-22SGDS	CMMS22-34SL2	MM5-22SDGDSL	MMD1S22-5SK2030	MM7-22SDGDS	MMD1S22-7SL2
CMM34-22SGDS-25	CMMS22-34SL2L	MM5-22SDGDW	MMD1S22-5	MM7-22SDGDS-25	MMD1S22-7SL2L
CMM34-22SGDSK	CMMS22-34SK2	MM5-22SDGDH	MMS22-5026	MM7-22SDGDSK	MMD1S22-7SK2
CMM34-22SGDSKH	CMMS22-34SK2H	MM5-22SGDH	MMS22-5026H	MM7-22SDGDSKH	MMD1S22-7SK2H
CMM34-22SGDSL	CMMS22-34SK2030	MM5-22SGDS	MMS22-5SL2	MM7-22SDGDSL	MMD1S22-7SK2030
CMM34-22SGDW	CMMS22-34	MM5-22SGDS-25	MMS22-5SL2L	MM7-22SDGDW	MMD1S22-7
CMM44-22SDGD	CMMD1S22-44026	MM5-22SGDSK	MMS22-5SK2	MM7-22SGD	MMS22-7026
CMM44-22SDGDH	CMMD1S22-44026H	MM5-22SGDSKH	MMS22-5SK2H	MM7-22SGDH	MMS22-7026H
CMM44-22SDGDS	CMMD1S22-44SL2	MM5-22SGDSL	MMS22-5SK2030	MM7-22SGDS	MMS22-7SL2
CMM44-22SDGDS-25	CMMD1S22-44SL2L	MM5-22SGDW	MMS22-5	MM7-22SGDS-25	MMS22-7SL2L



# Cross Reference - Continental



Vishay Dale

Continental/Vishay Dale Rack and Panel Connectors -  
Microminiature, Subminiature, Miniature

CONTINENTAL	VISHAY DALE	CONTINENTAL	VISHAY DALE	CONTINENTAL	VISHAY DALE
MM7-22SGDSK	MMS22-7SK2	MM9-22SGD	MMS22-9026	MM11-22SDGDSK	MMD1S22-11SK2
MM7-22SGDSKH	MMS22-7SK2H	MM9-22SGDH	MMS22-9026H	MM11-22SDGDSKH	MMD1S22-11SK2H
MM7-22SGDSL	MMS22-7SK2030	MM9-22SGDS	MMS22-9SL2	MM11-22SDGDSL	MMD1S22-11SK2030
MM7-22SSGDW	MMS22-7	MM9-22SGDS-25	MM S22-9SL2L	MM11-22SDGDW	MMD1S22-11
MM7-24PDGD	MMD1P24-7026	MM9-22SGDSK	MMS22-9SK2	MM11-22SGD	MMS22-11026
MM7-24PDGDH	MMD1P24-7026H	MM9-22SGDSKH	MMS22-9SK2H	MM11-22SGDH	MMS22-11026H
MM7-24PDGDS	MMD1P24-7SL2	MM9-22SGDSL	MMS22-9SK2030	MM11-22SGDS	MMS22-11SL2
MM7-24PDGDS-25	MMD1P24-7SL2L	MM9-22SGDW	MMS22-9	MM11-22SGDS-25	MMS22-11SL2L
MM7-24PDGDSK	MMD1P24-7SK2	MM9-24PDGD	MMD1P24-9026	MM11-22SGDSK	MMS22-11SK2
MM7-24PDGDSKH	MMD1P24-7SK2H	MM9-24PDGDH	MMD1P24-9026H	MM11-22SGDSKH	MMS22-11SK2H
MM7-24PDGDSL	MMD1P24-7SK2030	MM9-24PDGDS	MMD1P24-9SL2	MM11-22SGDSL	MMS22-11SK2030
MM7-24-PDGDW	MMD1P24-7	MM9-24PDGDS-25	MMD1P24-9SL2L	MM11-22SGDW	MMS22-11
MM7-24PGD	MMP24-7026	MM9-24PDGDSK	MMD1P24-9SK2	MM11-24PDGD	MMD1P24-11026
MM7-24PGDH	MMP24-7026H	MM9-24PDGDSKH	MMD1P24-9SK2H	MM11-24PDGDH	MMD1P24-11026H
MM7-24PGDS	MMP24-7SL2	MM9-24PDGDSL	MMD1P24-9SK2030	MM11-24PDGDS	MMD1P24-11SL2
MM7-24PGDS-25	MMP24-7SL2L	MM9-24PDGDW	MMD1P24-9	MM11-24PDGDS-25	MMD1P24-11SL2L
MM7-24PGDSK	MMP24-7SK2	MM9-24PGD	MMP24-9026	MM11-24PDGDSK	MMD1P24-11SK2
MM7-24PGDSKH	MMP24-7SK2H	MM9-24PGDH	MMP24-9026H	MM11-24PDGDSKH	MMD1P24-11SK2H
MM7-24PGDSL	MMP24-7SK2030	MM9-24PGDS	MMP24-9SL2	MM11-24PDGDSL	MMD1P24-11SK2030
MM7-24PGDW	MMP24-7	MM9-24PGDS-25	MMP24-9SL2L	MM11-24PDGDW	MMD1P24-11
MM7-24SDGD	MMD1S24-7026	MM9-24PGDSK	MMP24-9SK2	MM11-24PGD	MMP24-11026
MM7-24SDGDH	MMD1S24-7026H	MM9-24PGDSKH	MMP24-9SK2H	MM11-24PGDH	MMP24-11026H
MM7-24SDGDS	MMD1S24-7SL2	MM9-24PGDSL	MMP24-9SK2030	MM11-24PGDS	MMP24-11SL2
MM7-24SDGDS-25	MMD1S24-7SL2L	MM9-24PGDW	MMP24-9	MM11-24PGDS-25	MMP24-11SL2L
MM7-24SDGDSK	MMD1S24-7SK2	MM9-24SDGD	MMD1S24-9026	MM11-24PGDSK	MMP24-11SK2
MM7-24SDGDSKH	MMD1S24-7SK2H	MM9-24SDGDH	MMD1S24-9026H	MM11-24PGDSKH	MMP24-11SK2H
MM7-24SDGDSL	MMD1S24-7SK2030	MM9-24SDGDS	MMD1S24-9SL2	MM11-24PGDSL	MMP24-11SK2030
MM7-24SDGDW	MMD1S24-7	MM9-24SDGDS-25	MMD1S24-9SL2L	MM11-24PGDW	MMP24-11
MM7-24SGD	MMS24-7026	MM9-24SDGDSK	MMD1S24-9SK2	MM11-24SDGD	MMD1S24-11026
MM7-24SGDH	MMS24-7026H	MM9-24SDGDSKH	MMD1S24-9SK2H	MM11-24SDGDH	MMD1S24-11026H
MM7-24SGDS	MMS24-7SL2	MM9-24SDGDSL	MMD1S24-9SK2030	MM11-24SDGDS	MMD1S24-11SL2
MM7-24SGDS-25	MMS24-7SL2L	MM9-24SDGDW	MMD1S24-9	MM11-24SDGDS-25	MMD1S24-11SL2L
MM7-24SGDSK	MMS24-7SK2	MM9-24SGD	MMS24-9026	MM11-24SDGDSK	MMD1S24-11SK2
MM7-24SGDSKH	MMS24-7SK2H	MM9-24SGDH	MMS24-9026H	MM11-24SDGDSKH	MMD1S24-11SK2H
MM7-24SGDSL	MMS24-7SK2030	MM9-24SGDS	MMS24-9SL2	MM11-24SDGDSL	MMD1S24-11SK2030
MM7-24SGDW	MMS24-7	MM9-24SGDS-25	MMS24-9SL2L	MM11-24SDGDW	MMD1S24-11
MM9-22PDGD	MMD1P22-9026	MM9-24SGDSK	MMS24-9SK2	MM11-24SGD	MMS24-11026
MM9-22PDGDH	MMD1P22-9026H	MM9-24SGDSKH	MMS24-9SK2H	MM11-24SGDH	MMS24-11026H
MM9-22PDGDS	MMD1P22-9SL2	MM9-24SGDSL	MMS24-9SK2030	MM11-24SGDS	MMS24-11SL2
MM9-22PDGDS-25	MMD1P22-9SL2L	MM9-24SGDW	MMS24-9	MM11-24SGDS-25	MMS24-11SL2L
MM9-22PDGDSK	MMD1P22-9SK2	MM11-22PDGD	MMD1P22-11026	MM11-24SGDSK	MMS24-11SK2
MM9-22PDGDSKH	MMD1P22-9SK2H	MM11-22PDGDH	MMD1P22-11026H	MM11-24SGDSKH	MMS24-11SK2H
MM9-22PDGDSL	MMD1P22-9SK2030	MM11-22PDGDS	MMD1P22-11SL2	MM11-24SGDSL	MMS24-11SK2030
MM9-22PDGDW	MMD1P22-9	MM11-22PDGDS-25	MMD1P22-11SL2L	MM11-24SGDW	MMS24-11
MM9-22PGD	MMP22-9026	MM11-22PDGDSK	MMD1P22-11SK2	MM14-22PDGD	MMD1P22-14026
MM9-22PGDH	MMP22-9026H	MM11-22PDGDSKH	MMD1P22-11SK2H	MM14-22PDGDH	MMD1P22-14026H
MM9-22PGDS	MMP22-9SL2	MM11-22PDGDSL	MMD1P22-11SK2030	MM14-22PDGDS	MMD1P22-14SL2
MM9-22PGDS-25	MMP22-9SL2L	MM11-22PDGDW	MMD1P22-11	MM14-22PDGDS-25	MMD1P22-14SL2L
MM9-22PGDSK	MMP22-9SK2	MM11-22PGD	MMP22-11026	MM14-22PDGDSK	MMD1P22-14SK2
MM9-22PGDSKH	MMP22-9SK2H	MM11-22PGDH	MMP22-11026H	MM14-22PDGDSKH	MMD1P22-14SK2H
MM9-22PGDSL	MMP22-9SK2030	MM11-22PGDS	MMP22-11SL2	MM14-22PDGDSL	MMD1P22-14SK2030
MM9-22PGDW	MMP22-9	MM11-22PGDS-25	MMP22-11SL2L	MM14-22PDGDW	MMD1P22-14
MM9-22SDGD	MMD1S22-9026	MM11-22PGDSK	MMP22-11SK2	MM14-22PGD	MMD22-14026
MM9-22SDGDH	MMD1S22-9026H	MM11-22PGDSKH	MMP22-11SK2H	MM14-22PGDH	MMP22-14026H
MM9-22SDGDS	MMD1S22-9SL2	MM11-22PGDSL	MMP22-11SK2030	MM14-22PGDS	MMP22-14SL2
MM9-22SDGDS-25	MMD1S22-9SL2L	MM11-22PGDW	MMP22-11	MM14-22PGDS-25	MMP22-14SL2L
MM9-22SDGDSK	MMD1S22-9SK2	MM11-22SDGD	MMD1S22-11026	MM14-22PGDSK	MMP22-14SK2
MM9-22SDGDSKH	MMD1S22-9SK2H	MM11-22SDGDH	MMD1S22-11026H	MM14-22PGDSKH	MMP22-14SK2H
MM9-22SDGDSL	MMD1S22-9SK2030	MM11-22SDGDS	MMD1S22-11SL2	MM14-22PGDSL	MMP22-14SK2030
MM9-22SDGDW	MMD1S22-9	MM11-22SDGDS-25	MMD1S22-11SL2L	MM14-22PGDW	MMP22-14



# Cross Reference - Continental

Continental/Vishay Dale Rack and Panel Connectors -  
Microminiature, Subminiature, Miniature

Vishay Dale

CONTINENTAL	VISHAY DALE	CONTINENTAL	VISHAY DALE	CONTINENTAL	VISHAY DALE
MM14-22SDGD	MMD1S22-14026	MM18-22PGDSK	MMP22-18SK2	MM20-22PGD	MMP22-20026
MM14-22SDGDH	MMD1S22-14026H	MM18-22PGDSKH	MMP22-18SK2H	MM20-22PGDH	MMP22-20026H
MM14-22SDGDS	MMD1S22-14SL2	MM18-22PGDSL	MMP22-18SK2030	MM20-22PGDS	MMP22-20SL2
MM14-22SDGDS-25	MMD1S22-14SL2L	MM18-22PGDW	MMP22-18	MM20-22PGDS-25	MMP22-20SL2L
MM14-22SDGDSK	MMD1S22-14SK2	MM18-22SDGD	MMD1S22-18026	MM20-22PGDSK	MMP22-20SK2
MM14-22SDGDSKH	MMD1S22-14SK2H	MM18-22SDGDH	MMD1S22-18026H	MM20-22PGDSKH	MMP22-20SK2H
MM14-22SDGDSL	MMD1S22-14SK2030	MM18-22SDGDS	MMD1S22-18SL2	MM20-22PGDSL	MMP22-20SK2030
MM14-22SDGDW	MMD1S22-14	MM18-22SDGDS-25	MMD1S22-18SL2L	MM20-22PGDW	MMP22-20
MM14-22SGD	MMS22-14026	MM18-22SDGDSK	MMD1S22-18SK2	MM20-22PGDGD	MMD1S22-20026
MM14-22SGDH	MMS22-14026H	MM18-22SDGDSKH	MMD1S22-18SK2H	MM20-22SDGDH	MMD1S22-20026H
MM14-22SGDS	MMS22-14SL2	MM18-22SDGDSL	MMD1S22-18SK2030	MM20-22SDGDS	MMD1S22-20SL2
MM14-22SGDS-25	MMS22-14SL2L	MM18-22SDGDW	MMD1S22-18	MM20-22SDGDS-25	MMD1S22-20SL2L
MM14-22SGDSK	MMS22-14SK2	MM18-22SGD	MMS22-18026	MM20-22SDGDSK	MMD1S22-20SK2
MM14-22SGDSKH	MMS22-14SK2H	MM18-22SGDH	MMS22-18026H	MM20-22SDGDSKH	MMD1S22-20SK2H
MM14-22SGDSL	MMS22-14SK2030	MM18-22SGDS	MMS22-18SL2	MM20-22SDGDSL	MMD1S22-20SK2030
MM14-22SGDW	MMS22-14	MM18-22SGDS-25	MMS22-18SL2L	MM20-22SDGDW	MMD1S22-20
MM14-24PDGD	MMD1P24-14026	MM18-22SGDSK	MMS22-18SK2	MM20-22SGD	MMS22-20026
MM14-24PDGDH	MMD1P24-14026H	MM18-22SGDSKH	MMS22-18SK2H	MM20-22SGDH	MMS22-20026H
MM14-24PDGDS	MMD1P24-14SL2	MM18-22SGDSL	MMS22-18SK2030	MM20-22SGDS	MMS22-20SL2
MM14-24PDGDS-25	MMD1P24-14SL2L	MM18-22SGDW	MMS22-18	MM20-22SGDS-25	MMS22-20SL2L
MM14-24PDGDSK	MMD1P24-14SK2	MM18-24PDGD	MMD1P24-18026	MM20-22SGDSK	MMS22-20SK2
MM14-24PDGDSKH	MMD1P24-14SK2H	MM18-24PDGDH	MMD1P24-18026H	MM20-22SGDSKH	MMS22-20SK2H
MM14-24PDGDSL	MMD1P24-14SK2030	MM18-24PDGDS	MMD1P24-18SL2	MM20-22SGDSL	MMS22-20SK2030
MM14-24PDGDW	MMD1P24-14	MM18-24PDGDS-25	MMD1P24-18SL2L	MM20-22SGDW	MMS22-20
MM14-24PGD	MMP24-14026	MM18-24PDGDSK	MMD1P24-18SK2	MM20-24PDGD	MMD1P24-20026
MM14-24PGDH	MMP24-14026H	MM18-24PDGDSKH	MMD1P24-18SK2H	MM20-24PDGDH	MMD1P24-20026H
MM14-24PGDS	MMP24-14SL2	MM18-24PDGDSL	MMD1P24-18SK2030	MM20-24PDGDS	MMD1P24-20SL2
MM14-24PGDS-25	MMP24-14SL2L	MM18-24PDGDW	MMD1P24-18	MM20-24PDGDS-25	MMD1P24-20SL2L
MM14-24PGDSK	MMP24-14SK2	MM18-24PGD	MMP24-18026	MM20-24PDGDSK	MMD1P24-20SK2
MM14-24PGDSKH	MMP24-14SK2H	MM18-24PGDH	MMP24-18026H	MM20-24PDGDSKH	MMD1P24-20SK2H
MM14-24PGDSL	MMP24-14SK2030	MM18-24PGDS	MMP24-18SL2	MM20-24PDGDSL	MMD1P24-20SK2030
MM14-24PGDW	MMP24-14	MM18-24PGDS-25	MMP24-18SL2L	MM20-24PDGDW	MMD1P24-20
MM14-24SDGD	MMD1S24-14026	MM18-24PGDSK	MMP24-18SK2	MM20-24PGD	MMP24-20026
MM14-24SDGDH	MMD1S24-14026H	MM18-24PGDSKH	MMP24-18SK2H	MM20-24PGDH	MMP24-20026H
MM14-24SDGDS	MMD1S24-14SL2	MM18-24PGDSL	MMP24-18SK2030	MM20-24PGDS	MMP24-20SL2
MM14-24SDGDS-25	MMD1S24-14SL2L	MM18-24PGDW	MMP24-18	MM20-24PGDS-25	MMP24-20SL2L
MM14-24SDGDSK	MMD1S24-14SK2	MM18-24SGD	MMD1S24-18026	MM20-24PGDSK	MMP24-20SK2
MM14-24SDGDSKH	MMD1S24-14SK2H	MM18-24SGDH	MMD1S24-18026H	MM20-24PGDSKH	MMP24-20SK2H
MM14-24SDGDSL	MMD1S24-14SK2030	MM18-24SDGDS	MMD1S24-18SL2	MM20-24PGDSL	MMP24-20SK2030
MM14-24SDGDW	MMD1S24-14	MM18-24SDGDS-25	MMD1S24-18SL2L	MM20-24PGDW	MMP24-20
MM14-24SGD	MMS24-14026	MM18-24SDGDSK	MMD1S24-18SK2	MM20-24SDGD	MMD1S24-20026
MM14-24SGDH	MMS24-14026H	MM18-24SDGDSKH	MMD1S24-18SK2H	MM20-24SDGDH	MMD1S24-20026H
MM14-24SGDS	MMS24-14SL2	MM18-24SDGDSL	MMD1S24-18SK2030	MM20-24SDGDS	MMD1S24-20SL2
MM14-24SGDS-25	MMS24-14SL2L	MM18-24SDGDW	MMD1S24-18	MM20-24SDGDS-25	MMD1S24-20SL2L
MM14-24SGDSK	MMS24-14SK2	MM18-24SGD	MMS24-18026	MM20-24SDGDSK	MMD1S24-20SK2
MM14-24SGDSKH	MMS24-14SK2H	MM18-24SGDH	MMS24-18026H	MM20-24SDGDSKH	MMD1S24-20SK2H
MM14-24SGDSL	MMS24-14SK2030	MM18-24SGDS	MMS24-18SL2	MM20-24SDGDSL	MMD1S24-20SK2030
MM14-24SGDW	MMS24-14	MM18-24SGDS-25	MMS24-18SL2L	MM20-24SDGDW	MMD1S24-20
MM18-22PDGD	MMD1P22-18026	MM18-24SGDSK	MMS24-18SK2	MM20-24SGD	MMS24-20026
MM18-22PDGDH	MMD1P22-18026H	MM18-24SGDSKH	MMS24-18SK2H	MM20-24SGDH	MMS24-20026H
MM18-22PDGDS	MMD1P22-18SL2	MM18-24SGDSL	MMS24-18SK2030	MM20-24SGDS	MMS24-20SL2
MM18-22PDGDS-25	MMD1P22-18SL2L	MM18-24SGDW	MMS24-18	MM20-24SGDS-25	MMS24-20SL2L
MM18-22PDGDSK	MMD1P22-18SK2	MM20-22PDGD	MMS24-18026	MM20-24SGDSK	MMS24-20SK2
MM18-22PDGDSKH	MMD1P22-18SK2H	MM20-22PDGDH	MMD1P22-20026	MM20-24SGDSKH	MMS24-20SK2H
MM18-22PDGDSL	MMD1P22-18SK2030	MM20-22PDGDS	MMD1P22-20SL2	MM20-24SGDSL	MMS24-20SK2030
MM18-22PDGDW	MMD1P22-18	MM20-22PDGDS-25	MMD1P22-20SL2L	MM20-24SGDW	MMS24-20
MM18-22PGD	MMP22-18026	MM20-22PDGDSK	MMD1P22-20SK2	MM26-22PDGD	MMD1P22-26026
MM18-22PGDH	MMP22-18026H	MM20-22PDGDSKH	MMD1P22-20SK2H	MM26-22PDGDH	MMD1P22-26026H
MM18-22PGDS	MMP22-18SL2	MM20-22PDGDSL	MMD1P22-20SK2030	MM26-22PGDGS	MMD1P22-26SL2
MM18-22PGDS-25	MMP22-18SL2L	MM20-22PDGDW	MMD1P22-20	MM26-22PGDGS-25	MMD1P22-26SL2L

# Cross Reference - Continental



Vishay Dale

Continental/Vishay Dale Rack and Panel Connectors -  
Microminiature, Subminiature, Miniature

CONTINENTAL	VISHAY DALE	CONTINENTAL	VISHAY DALE	CONTINENTAL	VISHAY DALE
MM26-22PDGDSK	MMD1P22-26SK2	MM29-22PDGD	MMD1P22-29026	MM29-24SGDSK	MMS24-29SK2
MM26-22PDGDSKH	MMD1P22-26SK2H	MM29-22PDGDH	MMD1P22-29026H	MM29-24SGDSKH	MMS24-29SK2H
MM26-22PDGDSL	MMD1P22-26SK2030	MM29-22PDGDS	MMD1P22-29SL2	MM29-24SGDSL	MMS24-29SK2030
MM26-22PDGDW	MMD1P22-26	MM29-22PDGDS-25	MMD1P22-29SL2L	MM29-24SGDW	MMS24-29
MM26-22PGD	MMP22-26026	MM29-22PDGDSK	MMD1P22-29SK2	MM34-22PDGD	MMD1P22-34026
MM26-22PGDH	MMP22-26026H	MM29-22PDGDSKH	MMD1P22-29SK2H	MM34-22PDGDH	MMD1P22-34026H
MM26-22PGDS	MMP22-26SL2	MM29-22PDGDSL	MMD1P22-29SK2030	MM34-22PDGDS	MMD1P22-34SL2
MM26-22PGDS-25	MMP22-26SL2L	MM29-22PDGDW	MMD1P22-29	MM34-22PDGDS-25	MMD1P22-34SL2L
MM26-22PGDSK	MMP22-26SK2	MM29-22PGD	MMP22-29026	MM34-22PDGDSK	MMD1P22-34SK2
MM26-22PGDSKH	MMP22-26SK2H	MM29-22PGDH	MMP22-29026H	MM34-22PDGDSKH	MMD1P22-34SK2H
MM26-22PGDSL	MMP22-26SK2030	MM29-22PGDS	MMP22-29SL2	MM34-22PDGDSL	MMD1P22-34SK2030
MM26-22PGDW	MMP22-26	MM29-22PGDS-25	MMP22-29SL2L	MM34-22PDGDW	MMD1P22-34
MM26-22SDGD	MMD1S22-26026	MM29-22PGDSK	MMP22-29SK2	MM34-22PGD	MMP22-34026
MM26-22SDGDH	MMD1S22-26026H	MM29-22PGDSKH	MMP22-29SK2H	MM34-22PGDH	MMP22-34026H
MM26-22SDGDS	MMD1S22-26SL2	MM29-22PGDSL	MMP22-29SK2030	MM34-22PGDS	MMP22-34SL2
MM26-22SDGDS-25	MMD1S22-26SL2L	MM29-22PGDW	MMP22-29	MM34-22PGDS-25	MMP22-34SL2L
MM26-22SDGDSK	MMD1S22-26SK2	MM29-22SDGD	MMD1S22-29026	MM34-22PGDSK	MMP22-34SK2
MM26-22SDGDSKH	MMD1S22-26SK2H	MM29-22SDGDH	MMD1S22-29026H	MM34-22PGDSKH	MMP22-34SK2H
MM26-22SDGDSL	MMD1S22-26SK2030	MM29-22SDGDS	MMD1S22-29SL2	MM34-22PGDSL	MMP22-34SK2030
MM26-22SDGDW	MMD1S22-26	MM29-22SDGDS-25	MMD1S22-29SL2L	MM34-22PGDW	MMP22-34
MM26-22SGD	MMS22-26026	MM29-22SDGDSK	MMD1S22-29SK2	MM34-22SDGD	MMD1S22-34026
MM26-22SGDH	MMS22-26026H	MM29-22SDGDSKH	MMD1S22-29SK2H	MM34-22SDGDH	MMD1S22-34026H
MM26-22SGDS	MMS22-26SL2	MM29-22SDGDSL	MMD1S22-29SK2030	MM34-22SDGDS	MMD1S22-34SL2
MM26-22SGDS-25	MMS22-26SL2L	MM29-22SDGDW	MMD1S22-29	MM34-22SDGDS-25	MMD1S22-34SL2L
MM26-22SGDSK	MMS22-26SK2	MM29-22SGD	MMS22-29026	MM34-22SDGDSK	MMD1S22-34SK2
MM26-22SGDSKH	MMS22-26SK2H	MM29-22SGDH	MMS22-29026H	MM34-22SDGDSKH	MMD1S22-34SK2H
MM26-22SGDSL	MMS22-26SK2030	MM29-22SGDS	MMS22-29SL2	MM34-22SGDSL	MMD1S22-34SK2030
MM26-22SGDW	MMS22-26	MM29-22SGDS-25	MMS22-29SL2L	MM34-22SGDW	MMD1S22-34
MM2624PDGD	MMD1P24-26026	MM29-22SGDSK	MMS22-29SK2	MM34-22SDGD	MMS22-34026
MM2624PDGDH	MMD1P24-26026H	MM29-22SGDSKH	MMS22-29SK2H	MM34-22SGDH	MMS22-34026H
MM2624PDGDS	MMD1P24-26SL2	MM29-22SGDSL	MMS22-29SK2030	MM34-22SGDS	MMS22-34SL2
MM2624PDGDS-25	MMD1P24-26SL2L	MM29-22SGDW	MMS22-29	MM34-22SGDS-25	MMS22-34SL2L
MM2624PDGDSK	MMD1P24-26SK2	MM29-24PDGD	MMD1P24-29026	MM34-22SGDSK	MMS22-34SK2
MM2624PDGDSKH	MMD1P24-26SK2H	MM29-24PDGDH	MMD1P24-29026H	MM34-22SGDSKH	MMS22-34SK2H
MM26-24PDGDSL	MMD1P24-26SK2030	MM29-24PDGDS	MMD1P24-29SL2	MM34-22SGDSL	MMS22-34SK2030
MM26-24PDGDW	MMD1P24-26	MM29-24PDGDS-25	MMD1P24-29SL2L	MM34-22SGDW	MMS22-34
MM2624PGD	MMP24-26026	MM29-24PDGDSK	MMD1P24-29SK2	MM34-24PDGD	MMD1P24-34026
MM26-24PGDH	MMP24-26026H	MM29-24PDGDSKH	MMD1P24-29SK2H	MM34-24PDGDH	MMD1P24-34026H
MM26-24PGDS	MMP24-26SL2	MM29-24PDGDSL	MMD1P24-29SK2030	MM34-24PDGDS	MMD1P24-34SL2
MM26-24PGDS-25	MMP24-26SL2L	MM29-24PDGDW	MMD1P24-29	MM34-24PDGDS-25	MMD1P24-34SL2L
MM26-24PGDSK	MMP24-26SK2	MM29-24PGD	MMP24-29026	MM34-24PDGDSK	MMD1P24-34SK2
MM26-24PGDSKH	MMP24-26SK2H	MM29-24PGDH	MMP24-29026H	MM34-24PDGDSKH	MMD1P24-34SK2H
MM26-24PGDSL	MMP24-26SK2030	MM29-24PGDS	MMP24-29SL2	MM34-24PDGDSL	MMD1P24-34SK2030
MM26-24PGDW	MMP24-26	MM29-24PGDS-25	MMP24-29SL2L	MM34-24-PDGDW	MMD1P24-34
MM2624SDGD	MMD1S24-26026	MM29-24PGDSK	MMP24-29SK2	MM34-24PGD	MMP24-34026
MM2624SDGDH	MMD1S24-26026H	MM29-24PGDSKH	MMP24-29SK2H	MM34-24PGDH	MMP24-34026H
MM2624SDGDS	MMD1S24-26SL2	MM29-24PGDSL	MMP24-29SK2030	MM34-24PGDS	MMP24-34SL2
MM2624SDGDS-25	MMD1S24-26SL2L	MM29-24PGDW	MMP24-29	MM34-24PGDS-25	MMP24-34SL2L
MM2624SDGDSK	MMD1S24-26SK2	MM29-24SDGD	MMD1S24-29026	MM34-24PGDSK	MMP24-34SK2
MM2624SDGDSKH	MMD1S24-26SK2H	MM29-24SDGDH	MMD1S24-29026H	MM34-24PGDSKH	MMP24-34SK2H
MM26-24SDGDSL	MMD1S24-26SK2030	MM29-24SDGDS	MMD1S24-29SL2	MM34-24PGDSL	MMP24-34SK2030
MM26-24SDGDW	MMD1S24-26	MM29-24SDGDS-25	MMD1S24-29SL2L	MM34-24PGDW	MMP24-34
MM2624SGD	MMS24-26026	MM29-24SDGDSK	MMD1S24-29SK2	MM34-24SDGD	MMD1S24-34026
MM26-24SGDH	MMS24-26026H	MM29-24SDGDSKH	MMD1S24-29SK2H	MM34-24SDGDH	MMD1S24-34026H
MM26-24SGDS	MMS24-26SL2	MM29-24SDGDSL	MMD1S24-29SK2030	MM34-24SDGDS	MMD1S24-34SL2
MM26-24SGDS-25	MMS24-26SL2L	MM29-24SDGDW	MMD1S24-29	MM34-24SDGDS-25	MMD1S24-34SL2L
MM26-24SGDSK	MMS24-26SK2	MM29-24SGD	MMS24-29026	MM34-24SDGDSK	MMD1S24-34SK2
MM26-24SGDSKH	MMS24-26SK2H	MM29-24SGDH	MMS24-29026H	MM34-24SDGDSKH	MMD1S24-34SK2H
MM26-24SGDSL	MMS24-26SK2030	MM29-24SGDS	MMS24-29SL2	MM34-24SDGDSL	MMD1S24-34SK2030
MM26-24SGDW	MMS24-26	MM29-24SGDS-25	MMS24-29SL2L	MM34-24SDGDW	MMD1S24-34



# Cross Reference - Continental

Continental/Vishay Dale Rack and Panel Connectors -  
Microminiature, Subminiature, Miniature

Vishay Dale

CONTINENTAL	VISHAY DALE	CONTINENTAL	VISHAY DALE	CONTINENTAL	VISHAY DALE
MM34-24SGD	MMS24-34026	MM44-24SDGDSK	MMD1S24-44SK2	MM50-24SDGD	MMD1S24-C50026
MM34-24SGDH	MMS24-34026H	MM44-24SDGDSKH	MMD1S24-44SK2H	MM50-24SDGDH	MMD1S24-C50026H
MM34-24SGDS	MMS24-34SL2	MM44-24SDGDSL	MMD1S24-44SK2030	MM50-24DGDS	MMD1S24-C50SL2
MM34-24SGDS-25	MMS24-34SL2L	MM44-24SDGDW	MMD1S24-44	MM50-24SDGDS-25	MMD1S24-C50SL2L
MM34-24SGDSK	MMS24-34SK2	MM44-24SGD	MMS24-44026	MM50-24SDGDSK	MMD1S24-C50SK2
MM34-24SGDSKH	MMS24-34SK2H	MM44-24SGDH	MMS24-44026H	MM50-24SDGDSKH	MMD1S24-C50SK2H
MM34-24SGDSL	MMS24-34SK2030	MM44-24SGDS	MMS24-44SL2	MM50-24SDGDSL	MMD1S24-C50SK2030
MM34-24SGDW	MMS24-34	MM44-24SGDS-25	MMS24-44SL2L	MM50-24SDGDW	MMD1S24-C50
MM44-22PDGD	MMD1P22-44026	MM44-24SGDSK	MMS24-44SK2	MM50-24SGD	MMS24-C50026
MM44-22PDGDH	MMD1P22-44026H	MM44-24SGDSKH	MMS24-44SK2H	MM50-24SGDH	MMS24-C50026H
MM44-22PDGDS	MMD1P22-44SL2	MM44-24SGDSL	MMS24-44SK2030	MM50-24SGDS	MMS24-C50SL2
MM44-22PDGDS-25	MMD1P22-44SL2L	MM44-24SGDW	MMS24-44	MM50-24SGDS-25	MMS24-C50SL2L
MM44-22PDGDSK	MMD1P22-44SK2	MM50-22PDGD	MMD1P22-C50026	MM50-24SGDSK	MMS24-C50SK2
MM44-22PDGDSKH	MMD1P22-44SK2H	MM50-22PDGDH	MMD1P22-C50026H	MM50-24SGDSKH	MMS24-C50SK2H
MM44-22PDGDSL	MMD1P22-44SK2030	MM50-22PDGDS	MMD1P22-C50SL2	MM50-24SGDSL	MMS24-C50SK2030
MM44-22PDGDW	MMD1P22-44	MM50-22PDGDS-25	MMD1P22-C50SL2L	MM50-24SGDW	MMS24-C50
MM44-22PGD	MMP22-44026	MM50-22PDGDSK	MMD1P22-C50SK2	SM5-20PDGD	SMDP20-5027
MM44-22PGDH	MMP22-44026H	MM50-22PDGDSKH	MMD1P22-C50SK2H	SM5-20PDGDH	SMDP20-5027H
MM44-22PGDS	MMP22-44SL2	MM50-22PDGDSL	MMD1P22-C50SK2030	SM5-20PDGDH-1	SMDP20-5027H1
MM44-22PGDS-25	MMP22-44SL2L	MM50-22PDGDW	MMD1P22-C50	SM5-20PDGDS	SMDP20-5SL
MM44-22PGDSK	MMP22-44SK2	MM50-22PGD	MMP22-C50026	SM5-20PDGDSK	SMDP20-5SK
MM44-22PGDSKH	MMP22-44SK2H	MM50-22PGDH	MMP22-C50026H	SM5-20PDGDSKH	SMDP20-5SKH
MM44-22PGDSL	MMP22-44SK2030	MM50-22PGDS	MMP22-C50SL2	SM5-20PDGDSKH-1	SMDP20-5SKH1
MM44-22PGDW	MMP22-44	MM50-22PGDS-25	MMP22-C50SL2L	SM5-20PDGDSL	SMDP20-5SK030
MM44-22SDGD	MMD1S22-44026	MM50-22PGDSK	MMP22-C50SK2	SM5-20PDGDW	SMDP20-5
MM44-22SDGDH	MMD1S22-44026H	MM50-22PGDSKH	MMP22-C50SK2H	SM5-20PGD	SMP20-5027
MM44-22SDGDS	MMD1S22-44SL2	MM50-22PGDSL	MMP22-C50SK2030	SM5-20PGDH	SMP20-5027H
MM44-22SDGDS-25	MMD1S22-44SL2L	MM50-22PDGDW	MMP22-C50	SM5-20PGDH-1	SMP20-5027H1
MM44-22SDGDSK	MMD1S22-44SK2	MM50-22SDGD	MMD1S22-C50026	SM5-20PGDS	SMP20-5SL
MM44-22SDGDSKH	MMD1S22-44SK2H	MM50-22SDGDH	MMD1S22-C50026H	SM5-20PGDSK	SMP20-5SK
MM44-22SDGDSL	MMD1S22-44SK2030	MM50-22SDGDS	MMD1S22-C50SL2	SM5-20PGDSKH	SMP20-5SKH
MM44-22SDGDW	MMD1S22-44	MM50-22SDGDS-25	MMD1S22-C50SL2L	SM5-20PGDSKH-1	SMP20-5SKH1
MM44-22SGD	MMS22-44026	MM50-22SDGDSK	MMD1S22-C50SK2	SM5-20PGDSL	SMP20-5SK030
MM44-22SGDH	MMS22-44026H	MM50-22SDGDSKH	MMD1S22-C50SK2H	SM5-20PGDW	SMP20-5
MM44-22SGDS	MMS22-44SL2	MM50-22SDGDSL	MMD1S22-C50SK2030	SM5-20SDGD	SMDP20-5027
MM44-22SGDS-25	MMS22-44SL2L	MM50-22SDGDW	MMD1S22-C50	SM5-20SDGDH	SMDP20-5027H
MM44-22SGDSK	MMS22-44SK2	MM50-22SGD	MMS22-C50026	SM5-20SDGDH-1	SMDP20-5027H1
MM44-22SGDSKH	MMS22-44SK2H	MM50-22SGDH	MMS22-C50026H	SM5-20SDGDS	SMDP20-5SL
MM44-22SGDSL	MMS22-44SK2030	MM50-22SGDS	MMS22-C50SL2	SM5-20SDGDSK	SMDP20-5SK
MM44-22SGDW	MMS22-44	MM50-22SGDS-25	MMS22-C50SL2L	SM5-20SDGDSKH	SMDP20-5SKH
MM44-24PDGD	MMD1P24-44026	MM50-22SGDSK	MMS22-C50SK2	SM5-20SDGDSKH-1	SMDP20-5SKH1
MM44-24PDGDH	MMD1P24-44026H	MM50-22SGDSKH	MMS22-C50SK2H	SM5-20SDGDSL	SMDP20-5SK030
MM44-24PDGDS	MMD1P24-44SL2	MM50-22SGDSL	MMS22-C50SK2030	SM5-20SDGDW	SMDP20-5
MM44-24PDGDS-25	MMD1P24-44SL2L	MM50-22SGDW	MMS22-C50	SM5-20SGD	SMS20-5027
MM44-24PDGDSK	MMD1P24-44SK2	MM50-24PDGD	MMD1P24-C50026	SM5-20SGDH	SMS20-5027H
MM44-24PDGDSKH	MMD1P24-44SK2H	MM50-24PDGDH	MMD1P24-C50026H	SM5-20SGDH-1	SMS20-5027H1
MM44-24PDGDSL	MMD1P24-44SK2030	MM50-24PDGDS	MMD1P24-C50SL2	SM5-20SGDS	SMS20-5SL
MM44-24PDGDW	MMD1P24-44	MM50-24PDGDS-25	MMD1P24-C50SL2L	SM5-20SGDSK	SMS20-5SK
MM44-24PGD	MMP24-44026	MM50-24PDGDSK	MMD1P24-C50SK2	SM5-20SGDSKH	SMS20-5SKH
MM44-24PGDH	MMP24-44026H	MM50-24PDGDSKH	MMD1P24-C50SK2H	SM5-20SGDSKH-1	SMS20-5SKH1
MM44-24PGDS	MMP24-44SL2	MM50-24PDGDSL	MMD1P24-C50SK2030	SM5-20SGDSL	SMS20-5SK030
MM44-24PGDS-25	MMP24-44SL2L	MM50-24PDGDW	MMD1P24-C50	SM5-20SGDW	SMS20-5
MM44-24PGDSK	MMP24-44SK2	MM50-24PDGD	MMP24-C50026	SM7-20PDGD	SMDP20-7027
MM44-24PGDSKH	MMP24-44SK2H	MM50-24PDGDH	MMP24-C50026H	SM7-20PDGDH	SMDP20-7027H
MM44-24PGDSL	MMP24-44SK2030	MM50-24PGDS	MMP24-C50SL2	SM7-20PDGDH-1	SMDP20-7027H1
MM44-24PGDW	MMP24-44	MM50-24PGDS-25	MMP24-C50SL2L	SM7-20PDGDS	SMDP20-7SL
MM44-24SDGD	MMD1S24-44026	MM50-24PGDSK	MMP24-C50SK2	SM7-20PDGDSK	SMDP20-7SK
MM44-24SDGDH	MMD1S24-44026H	MM50-24PGDSKH	MMP24-C50SK2H	SM7-20PDGDSKH	SMDP20-7SKH
MM44-24SDGDS	MMD1S24-44SL2	MM50-24PGDSL	MMP24-C50SK2030	SM7-20-PDGDSKH-1	SMDP20-7SKH1
MM44-24SDGDS-25	MMD1S24-44SL2L	MM50-24PGDW	MMP24-C50	SM7-20PDGDSL	SMDP20-7SK030

# Cross Reference - Continental



Vishay Dale Continental/Vishay Dale Rack and Panel Connectors -  
Microminiature, Subminiature, Miniature

CONTINENTAL	VISHAY DALE	CONTINENTAL	VISHAY DALE	CONTINENTAL	VISHAY DALE
SM7-20PDGDW	SMDP20-7	SM11-20SGDSKH	SMS20-11SKH	SM20-20SDGDH-1	SMDS20-20027H1
SM7-20PGD	SMP20-7027	SM11-20SGDSKH-1	SMS20-11SKH1	SM20-20SDGDS	SMDS20-20SL
SM7-20PGDH	SMP20-7027H	SM11-20SGDSL	SMS20-11SK030	SM20-20SDGDSK	SMDS20-20SK
SM7-20PGDH-1	SMP20-7027H1	SM11-20SGDW	SMS20-11	SM20-20SDGDSKH	SMDS20-20SKH
SM7-20PGDS	SMP20-7SL	SM14-20PDGD	SMDP20-14027	SM20-20SDGDSKH-1	SMDS20-20SKH1
SM7-20PGDSK	SMP20-7SK	SM14-20PDGDH	SMDP20-14027H	SM20-20SDGDSL	SMDS20-20SK030
SM7-20PGDSKH	SMP20-7SKH	SM14-20PDGDH-1	SMDP20-14027H1	SM20-20SDGDW	SMDS20-20
SM7-20PGDSKH-1	SMP20-7SKH1	SM14-20PDGDS	SMDP20-14SL	SM20-20SGD	SMS20-20027
SM7-20PGDSL	SMP20-7SK030	SM14-20PDGDSK	SMDP20-14SK	SM20-20SGDH	SMS20-20027H
SM7-20PGDW	SMP20-7	SM14-20PDGDSKH	SMDP20-14SKH	SM20-20SGDH-1	SMS20-20027H1
SM7-20SDGD	SMDS20-7027	SM14-20PDGDSKH-1	SMDP20-14SKH1	SM20-20SGDS	SMS20-20SL
SM7-20SDGDH	SMDS20-7027H	SM14-20PDGDSL	SMDP20-14SK030	SM20-20SGDSK	SMS20-20SK
SM7-20SDGDH-1	SMDS20-7027H1	SM14-20PDGDW	SMDP20-14	SM20-20SGDSKH	SMS20-20SKH
SM7-20SDGDS	SMDS20-7SL	SM14-20PGD	SMP20-14027	SM20-20SGDSKH-1	SMS20-20SKH1
SM7-20SDGDSK	SMDS20-7SK	SM14-20PGDH	SMP20-14027H	SM20-20SGDSL	SMS20-20K030
SM7-20SDGDSKH	SMDS20-7SKH	SM14-20PGDH-1	SMP20-14027H1	SM20-20SGDW	SMS20-20
SM7-20SDGDSKH-1	SMDS20-7SKH1	SM14-20PGDS	SMP20-14SL	SM26-20PDGD	SMDP20-26027
SM7-20SDGDSL	SMDS20-7SK030	SM14-20PGDSK	SMP20-14SK	SM26-20PDGDH	SMDP20-26027H
SM7-20SDGDW	SMDS20-7	SM14-20PGDSKH	SMP20-14SKH	SM26-20PDGDH-1	SMDP20-26027H1
SM7-20SGD	SMS20-7027	SM14-20PGDSKH-1	SMP20-14SKH1	SM26-20PDGDS	SMDP20-26SL
SM7-20SGDH	SMS20-7027H	SM14-20PGDSL	SMP20-14SK030	SM26-20PDGDSK	SMDP20-26SKH
SM7-20SGDH-1	SMS20-7027H1	SM14-20PGDW	SMP20-14	SM26-20PDGDSKH-1	SMDP20-26-SKH1
SM7-20SGDS	SMS20-7SL	SM14-20SDGD	SMDS20-14027	SM26-20PDGDSL	SMDP20-26SK030
SM7-20SGDSK	SMS20-7SK	SM14-20SDGDH	SMDS20-14027H	SM26-20PDGDW	SMDP20-26
SM7-20SGDSKH	SMS20-7SKH	SM14-20SDGDH-1	SMDS20-14027H1	SM26-20PGD	SMP20-26027
SM7-20SGDSKH-1	SMS20-7SKH1	SM14-20SDGDS	SMDS20-14SL	SM26-20PGDH	SMP20-26027H
SM7-20SGDSL	SMS20-7SK030	SM14-20SDGDSK	SMDS20-14SK	SM26-20PGDH-1	SMP20-26027H1
SM7-20SGDW	SMS20-7	SM14-20SDGDSKH	SMDS20-14SKH	SM26-20PGDS	SMP20-26SL
SM11-20PDGD	SMDP20-11027	SM14-20SDGDSKH-1	SMDS20-14SKH1	SM26-20PGDSK	SMP20-26SK
SM11-20PDGDH	SMDP20-11027H	SM14-20SDGDSL	SMDS20-14SK030	SM26-20PGDSKH	SMP20-26SKH
SM11-20PDGDH-1	SMDP20-11027H1	SM14-20SDGDW	SMDS20-14	SM26-20PGDSKH-1	SMP20-26SKH1
SM11-20PDGDS	SMDP20-11SL	SM14-20SGD	SMS20-14027	SM26-20PGDSL	SMP20-26SK030
SM11-20PDGDSK	SMDP20-11SK	SM14-20SGDH	SMS20-14027H	SM26-20PGDW	SMP20-26
SM11-20PDGDSKH	SMDP20-11SKH	SM14-20SGDH-1	SMS20-14027H1	SM26-20SDGD	SMDS20-26027
SM11-20PDGDSKH-1	SMDP20-11SKH1	SM14-20SGDS	SMS20-14SL	SM26-20SDGDH	SMDS20-26027H
SM11-20PDGDSL	SMDP20-11SK030	SM14-20SGDSK	SMS20-14SK	SM26-20SDGDH-1	SMDS20-26027H1
SM11-20PDGDW	SMDP20-11	SM14-20SGDSKH	SMS20-14SKH	SM26-20SDGDS	SMDS20-26SL
SM11-20PGD	SMP20-11027	SM14-20SGDSKH-1	SMS20-14SKH1	SM26-20SDGDSK	SMDS20-26SK
SM11-20PGDH	SMP20-11027H	SM14-20SGDSL	SMS20-14SK030	SM26-20SDGDSKH	SMDS20-26SKH
SM11-20PGDH-1	SMP20-11027H1	SM14-20SGDW	SMS20-14		
SM11-20PGDS	SMP20-11SL	SM20-20PDGD	SMDP20-20027	SM26-20SDGDSKH-1	SMDS20-26SKH1
SM11-20PGDSK	SMP20-11SK	SM20-20PDGDH	SMDP20-20027H	SM26-20SDGDSL	SMDS20-26SK030
SM11-20PGDSKH	SMP20-11SKH	SM20-20PDGDH-1	SMDP20-20027H1	SM26-20SDGDW	SMDS20-26
SM11-20PGDSKH-1	SMP20-11SKH1	SM20-20PDGDS	SMDP20-20SL	SM26-20SGD	SMS20-26027
SM11-20PGDSL	SMP20-11SK030	SM20-20PDGDSK	SMDP20-20SK	SM26-20SGDH	SMS20-26027H
SM11-20PGDW	SMP20-11	SM20-20PDGDSKH	SMDP20-20SKH	SM26-20SGDH-1	SMS20-26027H1
SM11-20SDGD	SMDS20-11027	SM20-20PDGDSKH-1	SMDP20-20SKH1	SM26-20SGDS	SMS20-26SL
SM11-20SDGDH	SMDS20-11027H	SM20-20PDGDSL	SMDP20-20SK030	SM26-20SGDSK	SMS20-26SK
SM11-20SDGDH-1	SMDS20-11027H1	SM20-20PDGDW	SMDP20-20	SM26-20SGDSKH	SMS20-26SKH
SM11-20SDGDS	SMDS20-11SL	SM20-20PGD	SMP20-20027	SM26-20SGDSKH-1	SMS20-26SKH1
SM11-20SDGDSK	SMDS20-11SK	SM20-20PGDH	SMP20-20027H	SM26-20SGDSL	SMS20-26SK030
SM11-20SDGDSKH	SMDS20-11SKH	SM20-20PGDH-1	SMP20-20027H1	SM26-20SGDW	SMS20-26
SM11-20SDGDSKH-1	SMDS20-11SKH1	SM20-20PGDS	SMP20-20SL	SM34-20PDGD	SMDP20-34027
SM11-20SDGDSL	SMDS20-11SK030	SM20-20PGDSK	SMP20-20SK	SM34-20PDGDH	SMDP20-34027H
SM11-20SDGDW	SMDS20-11	SM20-20PGDSKH	SMP20-20SKH	SM34-20PDGDH-1	SMDP20-34027H1
SM11-20SGD	SMS20-11027	SM20-20PGDSKH-1	SMP20-20SKH1	SM34-20PDGDS	SMDP20-34SL
SM11-20SGDH	SMS20-11027H	SM20-20PGDSL	SMP20-20SK030	SM34-20PDGDSK	SMDP20-34SK
SM11-20SGDH-1	SMS20-11027H1	SM20-20PGDW	SMP20-20	SM34-20PDGDSKH	SMDP20-34SKH
SM11-20SGDS	SMS20-11SL	SM20-20SDGD	SMDP20-20027	SM34-20PDGDSKH-1	SMDP20-34SKH1
SM11-20SGDSK	SMS20-11SK	SM20-20SDGDH	SMDS20-20027H	SM34-20PDGDSL	SMDP20-34SK030





# Cross Reference - Continental

Continental/Vishay Dale Rack and Panel Connectors -  
Microminiature, Subminiature, Miniature

Vishay Dale

CONTINENTAL	VISHAY DALE	CONTINENTAL	VISHAY DALE	CONTINENTAL	VISHAY DALE
SM34-20PDGDW	SMDP20-34	SM42-20PGDW	SMP20-42	SM50-20SDGDW	SMDS20-50
SM34-20PGD	SMP20-34027	SM42-20SDGD	SMDS20-42027	SM50-20SGD	SMS20-50027
SM34-20PGDH	SMP20-34027H	SM42-20SDGDH	SMDS20-42027H	SM50-20SGDH	SMS20-50027H
SM34-20PGDH-1	SMP20-34027H1	SM42-20SDGDH-1	SMDS20-42027H1	SM50-20SGDH-1	SMS20-50027H1
SM34-20PGDS	SMP20-34SL	SM42-20SDGDS	SMDS20-42SL	SM50-20SGDS	SMS20-50SL
SM34-20PGDSK	SMP20-34SK	SM42-20SDGDSK	SMDS20-42SK	SM50-20SGDSK	SMS20-50SK
SM34-20PGDSKH	SMP20-34SKH	SM42-20SDGDSKH	SMDS20-42SKH	SM50-20SGDSKH	SMS20-50SKH
SM34-20PGDSKH-1	SMP20-34SKH1	SM42-20SDGDSKH-1	SMDS20-42SKH1	SM50-20SGDSKH-1	SMS20-50SKH1
SM34-20PGDSL	SMP20-34SK030	SM42-20SDGDSL	SMDS20-42SK030	SM50-20SGDSL	SMS20-50SK030
SM34-20PGDW	SMP20-34	SM42-20SDGDW	SMDS20-42	SM50-20SGDW	SMS20-50
SM34-20SDGD	SMDS20-34027	SM42-20SDGD	SMS20-42027	SM75-20PDGD	SMDP20-75027
SM34-20SDGDH	SMDS20-34027H	SM42-20SDGDH	SMS20-42027H	SM75-20PDGDH	SMDP20-75027H
SM34-20SDGDH-1	SMDS20-34027H1	SM42-20SDGDH-1	SMS20-42027H1	SM75-20PDGDH-1	SMDP20-75027H1
SM34-20SDGDS	SMDS20-34SL	SM42-20SDGDS	SMS20-42SL	SM75-20PDGDS	SMDP20-75SL
SM34-20SDGDSK	SMDS20-34SK	SM42-20SDGDSK	SMS20-42SK	SM75-20PDGDSK	SMDP20-75SK
SM34-20SDGDSKH	SMDS20-34SKH	SM42-20SDGDSKH	SMS20-42SKH	SM75-20PDGDSKH	SMDP20-75SKH
SM34-20SDGDSKH-1	SMDS20-34SKH1	SM42-20SDGDSKH-1	SMS20-42SKH1	SM75-20PDGDSKH-1	SMDP20-75SKH1
SM34-20SDGDSL	SMDS20-34SK030	SM42-20SDGDSL	SMS20-42SK030	SM75-20PDGDSL	SMDP20-75SK030
SM34-20SDGDW	SMDS20-34	SM42-20SDGDW	SMS20-42	SM75-20PDGDW	SMDP20-75
SM34-20SGD	SMS20-34027	SM50-20PDGD	SMDP20-50027	SM75-20PGD	SMP20-75027
SM34-20SGDH	SMS20-34027H	SM50-20PDGDH	SMDP20-50027H	SM75-20PGDH	SMP20-75027H
SM34-20SGDH-1	SMS20-34027H1	SM50-20PDGDH-1	SMDP20-50027H1	SM75-20PGDH-1	SMP20-75027H1
SM34-20SGDS	SMS20-34SL	SM50-20PDGDS	SMDP20-50SL	SM75-20PGDS	SMP20-75SL
SM34-20SGDSK	SMS20-34SK	SM50-20PDGDSK	SMP20-50SK	SM75-20PGDSK	SMP20-75SK
SM34-20SGDSKH	SMS20-34SKH	SM50-20PDGDSKH	SMDP20-50SKH	SM75-20PGDSKH	SMP20-75SKH
SM34-20SGDSKH-1	SMS20-34SKH1	SM50-20PDGDSKH-1	SMDP20-50SKH1	SM75-20PGDSKH-1	SMP20-75SKH1
SM34-20SGDSL	SMS20-34SK030	SM50-20PDGDSL	SMDP20-50SK030	SM75-20PGDSL	SMP20-75SK030
SM34-20SGDW	SMS20-34	SM50-20PDGDW	SMDP20-50	SM75-20PGDW	SMP20-75
SM42-20PDGD	SMDP20-42027	SM50-20PGD	SMP20-50027	SM75-20SDGD	SMDS20-75027
SM42-20PDGDH	SMDP20-42027H	SM50-20PGDH	SMP20-50027H	SM75-20SDGDH	SMDS20-75027H
SM42-20PDGDH-1	SMDP20-42027H1	SM50-20PGDH-1	SMP20-50027H1	SM75-20SDGDH-1	SMDS20-75027H1
SM42-20PDGDS	SMDP20-42SL	SM50-20PGDS	SMP20-50SL	SM75-20SDGDS	SMDS20-75SL
SM42-20PDGDSK	SMDP20-42SK	SM50-20PGDSK	SMP20-50SK	SM75-20SDGDSK	SMDS20-75SK
SM42-20PDGDSKH	SMDP20-42SKH	SM50-20PGDSKH	SMP20-50SKH	SM75-20SDGDSKH	SMDS20-75SKH
SM42-20PDGDSKH-1	SMDP20-42SKH1	SM50-20PGDSKH-1	SMP20-50SKH1	SM75-20SDGDSKH-1	SMDS20-75SKH1
SM42-20PDGDSL	SMDP20-42SK030	SM50-20PGDSL	SMP20-50SK030	SM75-20SDGDSL	SMDS20-75SK030
SM42-20PDGDW	SMDP20-42	SM50-20PGDW	SMP20-50	SM75-20SDGDW	SMDS20-75
SM42-20PGD	SMP20-42027	SM50-20SDGD	SMDS20-50027	SM75-20SGD	SMS20-75027
SM42-20PGDH	SMP20-42027H	SM50-20SDGDH	SMDS20-50027H	SM75-20SGDH	SMS20-75027H
SM42-20PGDH-1	SMP20-42027H1	SM50-20SDGDH-1	SMDS20-50027H1	SM75-20SGDH-1	SMS20-75027H1
SM42-20PGDS	SMP20-42SL	SM50-20SDGDS	SMDS20-50SL	SM75-20SGDS	SMS20-75SL
SM42-20PGDSK	SMP20-42SK	SM50-20SDGDSK	SMDS20-50SK	SM75-20SGDSK	SMS20-75SK
SM42-20PGDSKH	SMP20-42SKH	SM50-20SDGDSKH	SMDS20-50SKH	SM75-20SGDSKH	SMS20-75SKH
SM42-20PGDSKH-1	SMP20-42SKH1	SM50-20SDGDSKH-1	SMDS20-50SKH1	SM75-20SGDSKH-1	SMS20-75SKH1
SM42-20PGDSL	SMP20-42SK030	SM50-20SDGDSL	SMDS20-50SK030	SM75-20SGDSL	SMS20-75SK030
				SM75-20SGDW	SMS20-75

## SIDE MOUNTS

CONTINENTAL	VISHAY DALE	CONTINENTAL	VISHAY DALE	CONTINENTAL	VISHAY DALE
G2-20P	G20P-A	G4-20P	A20P-AB	W4-20P	WA20P-AB
G2-20PP	G20P-AB	G4-20PP	A20P-ABCD	W4-20S	WA20S-AB
G2-20S	G20S-A	G4-20S	A20S-AB	WW4-20PP	WA20P-ABCD
G2-20SS	G20S-AB	G4-20SS	A20S-ABCD	WW4-20SS	WA20S-ABCD

## Positronics/Vishay Dale Rack and Panel Connectors - Microminiature, Subminiature, Miniature

POSITRONICS	VISHAY DALE	POSITRONICS	VISHAY DALE	POSITRONICS	VISHAY DALE
SGM5FDS5E	MMD1S22-5SK2	SGM7FDS5T-250	MMD1S22-7SL	SGM9FSCT	MMS22-9SL2
SGM5FDS5E-250	MMD1S22-5SK	SGM7FSCE	MMS22-7SK2	SGM9FSCT-250	MMS22-9SL
SGM5FDSE1J	MMD1S22-5SK2H	SGM7FSCE-250	MMS22-7SK	SGM9MDS5E	MMD1P22-9SK2
SGM5FDS5E1J-250	MMD1S22-5SKH	SGM7FSCE1J	MMS22-7SK2H	SGM9MDS5E-250	MMD1P22-9SK
SGM5FDS5ESS	MMD1S22-5SK2030	SGM7FSCE1J-250	MMS22-7SKH	SGM9MDS5E1J	MMD1P22-9SK2H
SGM5FDS5ESS-250	MMD1S22-5SK030	SGM7FSCCESS	MMS22-7SK2030	SGM9MDS5E1J-250	MMD1P22-9SKH
SGM5FDS5N	MMD1S22-5026	SGM7FSCCESS-250	MMS22-7SK030	SGM9MDS5ESS	MMD1P22-9SK2030
SGM5FDS5NJ	MMD1S22-5026H	SGM7FSCFN	MMS22-7026	SGM9MDS5ESS-250	MMD1P22-9SK030
SGM5FDS5NSS	MMD1S22-5027	SGM7FSCNJ	MMS22-7026H	SGM9MDS5N	MMD1P22-9026
SGM5FDS5NSS-250	MMD1S22-5028	SGM7FSCNSS	MMS22-7027	SGM9MDS5NJ	MMD1P22-9026H
SGM5FDS5NSSJ	MMD1S22-5027H	SGM7FSCNSS-250	MMS22-7028	SGM9MDS5NSS	MMD1P22-9027
SGM5FDS5T	MMD1S22-5SL2	SGM7FSCNSSJ	MMS22-7027H	SGM9MDS5NSS-250	MMD1P22-9028
SGM5FDS5T-250	MMD1S22-5SL	SGM7FSCT	MMS22-7SL2	SGM9MDS5NSSJ	MMD1P22-9027H
SGM5FSCE	MMS22-5SK2	SGM7FSCT-250	MMS22-7SL	SGM9MDS5T	MMD1P22-9SL2
SGM5FSCE-250	MMS22-5SK	SGM7MDS5E	MMD1PS22-7SK2	SGM9MDS5T-250	MMD1P22-9SL
SGM5FSCE1J	MMS22-5SK2H	SGM7MDS5E-250	MMD1P22-7SK	SGM9MSCE	MMP22-9SK2
SGM5FSCE1J-250	MMS22-5SKH	SGM7MDS5E1J	MMD1P22-7SK2H	SGM9MSCE-250	MMP22-9SK
SGM5FSCCESS	MMS22-5SK2030	SGM7MDS5E1J-250	MMD1P22-7SKH	SGM9MSCE1J	MMP22-9SK2H
SGM5FSCCESS-250	MMS22-5SK030	SGM7MDS5ESS	MMD1P22-7SK2030	SGM9MSCE1J-250	MMP22-9SKH
SGM5FSCN	MMS22-5026	SGM7MDS5ESS-250	MMD1P22-7SK030	SGM9MCESS	MMP22-9SK2030
SGM5FSCNJ	MMS22-5026H	SGM7MDS5N	MMD1P22-7026	SGM9MCESS-250	MMP22-9SK030
SGM5FSCNSS	MMS22-5027	SGM7MDS5NJ	MMD1P22-7026H	SGM9MSCN	MMP22-9026
SGM5FSCNSS-250	MMS22-5028	SGM7MDS5NSS	MMD1P22-7027	SGM9MSCNJ	MMP22-9026H
SGM5FSCNSSJ	MMS22-5027H	SGM7MDS5NSS-250	MMD1P22-7028	SGM9MSCNSS	MMP22-9027
SGM5FSCT	MMS22-5SL2	SGM7MDS5NSSJ	MMD1P22-7027H	SGM9MSCNSS-250	MMP22-9028
SGM5FSCT-250	MMS22-5SL	SGM7MDS5T	MMD1P22-7SL2	SGM9MSCNSSJ	MMP22-9027H
SGM5MDS5E	MMD1P22-5SK2	SGM7MDS5T-250	MMD1P22-7SL	SGM9MSCT	MMP22-9SL2
SGM5MDS5E-250	MMD1P22-5SK	SGM7MSCE	MMP22-7SK2	SGM9MSCT-250	MMP22-9SL
SGM5MDS5E1J	MMD1P22-5SK2H	SGM7MSCE-250	MMP22-7SK	SGM11FDS5E	MMD1S22-11SK2
SGM5MDS5E1J-250	MMD1P22-5SKH	SGM7MSCE1J	MMP22-7SK2H	SGM11FDS5E-250	MMD1S22-11SK
SGM5MDS5ESS	MMD1P22-5SK2030	SGM7MSCE1J-250	MMP22-7SKH	SGM11FDS5E1J	MMD1S22-11SK2H
SGM5MDS5ESS-250	MMD1P22-5SK030	SGM7MSCESS	MMP22-7SK2030	SGM11FDS5E1J-250	MMD1S22-11SKH
SGM5MDS5N	MMD1P22-5026	SGM7MSCESS-250	MMP22-7SK030	SGM11FDS5ESS	MMD1S22-11SK2030
SGM5MDS5NJ	MMD1P22-5026H	SGM7MSCN	MMP22-7026	SGM11FDS5ESS-250	MMD1S22-11SK030
SGM5MDS5NSS	MMD1P22-5027	SGM7MSCNJ	MMP22-7026H	SGM11FDS5N	MMD1S22-11026
SGM5MDS5NSS-250	MMD1P22-5028	SGM7MSCNSS	MMP22-7027	SGM11FDS5NJ	MMD1S22-11026H
SGM5MDS5NSSJ	MMD1P22-5027H	SGM7MSCNSS-250	MMP22-7028	SGM11FDS5NSS	MMD1S22-11027
SGM5MDSST	MMD1P22-5SL2	SGM7MSCNSSJ	MMP22-7027H	SGM11FDS5NSS-250	MMD1S22-11028
SGM5MDS5T-250	MMD1P22-5SL	SGM7MSCT	MMP22-7SL2	SGM11FDS5NSSJ	MMD1S22-11027H
SGM5MSCE	MMP22-5SK2	SGM7MSCT-250	MMP22-7SL	SGM11FDS5T	MMD1S22-11SL2
SGM5MSCE-250	MMP22-5SK	SGM9FDS5E	MMD1S22-9SK2	SGM11FDS5T-250	MMD1S22-11SL
SGM5MSCE1J	MMP22-5SK2H	SGM9FDS5E-250	MMD1S22-9SK	SGM11FSCE	MMS22-11SK2
SGM5MSCE1J-250	MMP22-5SKH	SGM9FDS5E1J	MMD1S22-9SK2H	SGM11FSCE-250	MMS22-11SK
SGM5MSCESS	MMP22-5SK2030	SGM9FDS5E1J-250	MMD1S22-9SKH	SGM11FSCE1J	MMS22-11SK2H
SGM5MSCESS-250	MMP22-5SK030	SGM9FDS5ESS	MMD1S22-9SK2030	SGM11FSCE1J-250	MMS22-11SKH
SGM5MSCN	MMP22-5026	SGM9FDS5ESS-250	MMD1S22-9SK030	SGM11FSCESS	MMS22-11SK2030
SGM5MSCNJ	MMP22-5026H	SGM9FDS5N	MMD1S22-9026	SGM11FSCESS-250	MMS22-11SK030
SGM5MSCNSS	MMP22-5027	SGM9FDS5NJ	MMD1S22-9026H	SGM11FSCN	MMS22-11026
SGM5MSCNSS-250	MMP22-5028	SGM9FDS5NSS	MMD1S22-9027	SGM11FSCNJ	MMS22-11026H
SGM5MSCNSSJ	MMP22-5027H	SGM9FDS5NSS-250	MMD1S22-9028	SGM11FSCNSS	MMS22-11027
SGM5MSCT	MMP22-5SL2	SGM9FDS5NSSJ	MMD1S22-9027H	SGM11FSCNSS-250	MMS22-11028
SGM5MSCT-250	MMP22-5SL	SGM9FDS5T	MMD1S22-9SL2	SGM11FSCNSSJ	MMS22-11027H
SGM7FDS5E	MMD1S22-7SK2	SGM9FDS5T-250	MMD1S22-9SL	SGM11FSCT	MMS22-11SL2
SGM7FDS5E-250	MMD1S22-7SK	SGM9FSCE	MMS22-9SK2	SGM11FSCT-250	MMS22-11SL
SGM7FDS5E1J	MMD1S22-7SK2H	SGM9FSCE-250	MMS22-9SK	SGM11MDS5E	MMD1P22-11SK2
SGM7FDS5E1J-250	MMD1S22-7SKH	SGM9FSCE1J	MMS22-9SK2H	SGM11MDS5E-250	MMD1P22-11SK
SGM7FDS5ESS	MMD1S22-7SK2030	SGM9FSCE1J-250	MMS22-9SKH	SGM11MDS5E1J	MMD1P22-11SK2H
SGM7FDS5ESS-250	MMD1S22-7SK030	SGM9FSCCESS	MMS22-9SK2030	SGM11MDS5E1J-250	MMD1P22-11SKH
SGM7FDS5N	MMD1S22-7026	SGM9FSCCESS-250	MMS22-9SK030	SGM11MDS5ESS	MMD1P22-11SK2030
SGM7FDS5N	MMD1S22-7026H	SGM9FSCN	MMS22-9026	SGM11MDS5ESS-250	MMD1P22-11SK030



# Cross Reference - Positronics

Positronics/Vishay Dale Rack and Panel Connectors -  
Microminiature, Subminiature, Miniature

Vishay Dale

POSITRONICS	VISHAY DALE	POSITRONICS	VISHAY DALE	POSITRONICS	VISHAY DALE
SGM7FDS5NSS	MMD1S22-7207	SGM9FSCNJ	MMS22-9026H	SGM11MDS5N	MMD1P22-11026
SGM7FDS5NSS-250	MMD1S22-7208	SGM9FSCNSS	MMS22-9027	SGM11MDS5NJ	MMD1P22-11026H
SGM7FDS5NSSJ	MMD1S22-7207H	SGM9FSCNSS-250	MMS22-9028	SGM11MDS5NSS	MMD1P22-11027
SGM7FDS5T	MMD1S22-7SL2	SGM9FSCNSSJ	MMS22-9027H	SGM11MDS5NSS-250	MMD1P22-11028
SGM11MDS5NSSJ	MMD1P22-11027H	SGM14MSCNSSJ-250	MMS22-14028	SGM26FDS5NSS	MMD1S22-26027
SGM11MDS5T	MMD1P22-11SL2	SGM14MSCNSSJ	MMS22-14027H	SGM26FDS5NSS-250	MMD1S22-26028
SGM11MDS5T-250	MMD1P22-11SL	SGM14MSCT	MMS22-14SL2	SGM26FDS5NSSJ	MMD1S22-26027H
SGM11MSCE	MMP22-11SK2	SGM14MSCT-250	MMS22-14SL	SGM26FDS5T	MMD1S22-26SL2
SGM11MSCE-250	MMP22-11SK	SGM20FDS5E	MMD1S22-20SK2	SGM26FDS5T-250	MMD1S22-26SL
SGM11MSCE1J	MMP22-11SK2H	SGM20FDS5E-250	MMD1S22-20SK	SGM26FSCE	MMS22-26SK2
SGM11MSCE1J-250	MMP22-11SKH	SGM20FDS5E1J	MMD1S22-20SK2H	SGM26FSCE-250	MMS22-26SK
SGM11MSCESS	MMP22-11SK2030	SGM20FDS5E1J-250	MMD1S22-20SKH	SGM26FSCE1J	MMS22-26S1K2H
SGM11MSCESS-250	MMP22-11SK030	SGM20FDS5ESS	MMD1S22-20SK2030	SGM26FSCE1J-250	MMS22-26SKH
SGM11MSCN	MMP22-11026	SGM20FDS5ESS-250	MMD1S22-20SK030	SGM26FSCESS	MMS22-26SK2030
SGM11MSCNJ	MMD1S22-11026H	SGM20FDS5N	MMD1S22-20026	SGM26FSCESS-250	MMS22-26SK030
SGM11MSCNSS	MMP22-11027	SGM20FDS5NJ	MMD1S22-20026H	SGM26FSCN	MMS22-26026
SGM11MSCNSS-250	MMP22-11028	SGM20FDS5NSS	MMD1S22-20027	SGM26FSCNJ	MMS22-26026H
SGM11MSCNSSJ	MMP22-11027H	SGM20FDS5NSS-250	MMD1S22-20028	SGM26FSCNSS	MMS22-26027
SGM11MSCT	MMP22-11SL2	SGM20FDS5NSSJ	MMD1S22-20027H	SGM26FSCNSS-250	MMS22-26028
SGM11MSCT-250	MMP22-11SL	SGM20FDS5T	MMD1S22-20SL2	SGM26FSCNSSJ	MMS22-26027H
SGM14FDS5E	MMD1S22-14SK2	SGM20FDS5T-250	MMD1S22-20SL	SGM26FSCT	MMS22-26SL2
SGM14FDS5E-250	MMD1S22-14SK	SGM20FSCE	MMS22-20SK2	SGM26FSCT-250	MMS22-26SL
SGM14FDS5E1J	MMD1S22-14SK2H	SGM20FSCE-250	MMS22-20SK	SGM26MDS5E	MMD1P22-26SK2
SGM14FDS5E1J-250	MMD1S22-14SKH	SGM20FSCE1J	MMS22-20SK2H	SGM26MDS5E-250	MMD1P22-26SK
SGM14FDS5ESS	MMD1S22-14SK2030	SGM20FSCE1J-250	MMS22-20SKH	SGM26MDS5E1J	MMD1P22-26SK2H
SGM14FDS5ESS-250	MMD1S22-14SK030	SGM20FSCESS	MMS22-20SK2030	SGM26MDS5E1J-250	MMD1P22-26SKH
SGM14FDS5N	MMD1S22-14026	SGM20FSCESS-250	MMS22-20SK030	SGM26MDS5ESS	MMD1P22-26SK2030
SGM14FDS5NJ	MMD1S22-14026H	SGM20FSCN	MMS22-20026	SGM26MDS5ESS-250	MMD1P22-26SK030
SGM14FDS5NSS	MMD1S22-14027	SGM20FSCNJ	MMS22-20026H	SGM26MDS5N	MMD1P22-26026
SGM14FDS5NSS-250	MMD1S22-14028	SGM20FSCNSS	MMS22-20027	SGM26MDS5NJ	MMD1P22-26026H
SGM14FDS5NSSJ	MMD1S22-14027H	SGM20FSCNSS-250	MMS22-20028	SGM26MDS5NSS	MMD1P22-26027
SGM14FDS5T	MMD1S22-14SL2	SGM20FSCNSSJ	MMS22-20027H	SGM26MDS5NSS-250	MMD1P22-26028
SGM14FDS5T-250	MMD1S22-14SL	SGM20FSCT	MMS22-20SL2	SGM26MDS5NSSJ	MMD1P22-26027H
SGM14FSCE	MMS22-14SK2	SGM20FSCT-250	MMS22-20SL	SGM26MDS5T	MMD1P22-26SL2
SGM14FSCE-250	MMS22-14SK	SGM20MDS5E	MMD1P22-20SK2	SGM26MDS5T-250	MMD1P22-26SL
SGM14FSCE1J	MMS22-14SK2H	SGM20MDS5E-250	MMD1P22-20SK	SGM26MSCE	MMP22-26SK2
SGM14FSCE1J-250	MMS22-14SKH	SGM20MDS5E1J	MMD1P22-20SK2H	SGM26MSCE-250	MMP22-26SK
SGM14FSCESS	MMS22-14SK2030	SGM20MDS5E1J-250	MMD1P22-20SKH	SGM26MSCE1J	MMP22-26SK2H
SGM14FSCESS-250	MMS22-14SK030	SGM20MDS5ESS	MMD1P22-20SK2030	SGM26MSCE1J-250	MMP22-26SKH
SGM14FSCN	MMS22-14026	SGM20MDS5ESS-250	MMD1P22-20SK030	SGM26MSCESS	MMP22-26SK2030
SGM14FSCNJ	MMS22-14026H	SGM20MDS5N	MMD1P22-20026	SGM26MSCESS-250	MMP22-26SK030
SGM14FSCNSS	MMS22-14027	SGM20MDS5NJ	MMD1P22-20026H	SGM26MSCN	MMP22-26026
SGM14FSCNSS-250	MMS22-14028	SGM20MDS5NSS	MMD1P22-20027	SGM26MSCNJ	MMP22-26026H
SGM14FSCNSSJ	MMS22-14027H	SGM20MDS5NSS-250	MMD1P22-20028	SGM26MSCNSS	MMP22-26027
SGM14FSCT	MMS22-14SL2	SGM20MDS5NSSJ	MMD1P22-20027H	SGM26MSCNSS-250	MMP22-26028
SGM14FSCT-250	MMS22-14SL	SGM20MDS5T	MMD1P22-20SL2	SGM26MSCNSSJ	MMP22-26027H
SGM14MDS5E	MMD1P22-14SK2	SGM20MDS5T-250	MMD1P22-20SL	SGM26MSCT	MMP22-26SL2
SGM14MDS5E-250	MMD1P22-14SK	SGM20MSCE	MMP22-20SK2	SGM26MSCT-250	MMP22-26SL
SGM14MDS5E1J	MMD1P22-14SK2H	SGM20MSCE-250	MMP22-20SK	SGM29FDS5E	MMD1S22-29SK2
SGM14MDS5E1J-250	MMD1P22-14SKH	SGM20MSCE1J	MMP22-20SK2H	SGM29FDS5E-250	MMD1S22-29SK
SGM14MDS5ESS	MMD1P22-14SK2030	SGM20MSCE1J-250	MMP22-20SKH	SGM29FDS5E1J	MMD1S22-29SK2H
SGM14MDS5ESS-250	MMD1P22-14SK030	SGM20MSCESS	MMP22-20SK2030	SGM29FDS5EIJ-250	MMD1S22-29SKH
SGM14MDS5N	MMD1P22-14026	SGM20MSCESS-250	MMP22-20SK030	SGM29FDS5ESS	MMD1S22-29SK2030
SGM14MDS5NJ	MMD1P22-14026H	SGM20MSCN	MMP22-20026	SGM29FDS5ESS-250	MMD1S22-29SK030
SGM14MDS5NSS	MMD1P22-14027	SGM20MSCNJ	MMP22-20026H	SGM29FDS5N	MMD1S22-29026
SGM14MDS5NSS-250	MMD1P22-14028	SGM20MSCNSS	MMP22-20027	SGM29FDS5NJ	MMD1S22-29026H
SGM14MDS5NSSJ	MMD1P22-14027H	SSGM20MSCNSS-250	MMP22-20028	SGM29FDS5NSS	MMD1S22-29027
SGM14MDS5T	MMD1P22-14SL2	SGM20MSCNSSJ	MMP22-20027H	SGM29FDS5NSS-250	MMD1S22-29028
SGM14MDS5T-250	MMD1P22-14SL	SGM20MSCT	MMP22-20SL2	SGM29FDS5NSSJ	MMD1S22-29027H
SGM14MSCE	MMP22-14SK2	SGM20MSCT-250	MMP22-20SL	SGM29FDS5T	MMD1S22-29SL2



# Cross Reference - Positronics



Vishay Dale Positronics/Vishay Dale Rack and Panel Connectors -  
Microminiature, Subminiature, Miniature

<b>POSITRONICS</b>	<b>VISHAY DALE</b>	<b>POSITRONICS</b>	<b>VISHAY DALE</b>	<b>POSITRONICS</b>	<b>VISHAY DALE</b>
SGM14MSCE-250	MMP22-14SK	SGM26FDS5E	MMD1S22-26SK2	SGM29FDS5T-250	MMD1S22-29SL
SGM14MSCE1J	MMP22-14SK2H	SGM26FDS5E-250	MMD1S22-26SK	SGM29FSCSE	MMS22-29SK2
SGM14MSCE1J-250	MMP22-14SKH	SGM26FDS5E1J	MMD1S22-26SK2H	SGM29FSCSE-250	MMS22-29SK
SGM14MSCESS	MMP22-14SK2030	SGM26FDS5E1J-250	MMD1S22-26SKH	SGM29FSCSE1J	MMS22-29SK2H
SGM14MSCESS-250	MMP22-14SK030	SGM26FDS5ESS	MMD1S22-26SK2030	SGM29FSCSE1J-250	MMS22-29SKH
SGM14MSCN	MMP22-14026	SGM26FDS5ESS-250	MMD1S22-26SK030	SGM29FSCSESS	MMS22-29SK2030
SGM14MSCNJ	MMP22-14026H	SGM26FDS5N	MMD1S22-26026	SGM29FSCSESS-250	MMS22-29SK030
SGM14MSCNSS	MMP22-14027	SGM26FDS5NJ	MMD1S22-26026H	SGM29FSCSN	MMS22-29026
SGM29FSCNJ	MMS22-29026H	SGM34MDS5ESS	MMD1P22-34SK2030	SGM44MSCN-250	MMP22-44SK
SGM29FSCNSS	MMS22-29027	SGM34MDS5ESS-250	MMD1P22-34SK030	SGM44MSCE1J	MMP22-44SK2H
SGM29FSCNSS-250	MMS22-29028	SGM34MDS5N	MMD1P22-34026	SGM44MSCE1J-250	MMP22-44SKH
SGM29FSCNSSJ	MMS22-29027H	SGM34MDS5NJ	MMD1P22-34026H	SGM44MSCESS	MMP22-44SK2030
SGM29FSCST	MMS22-29SL2	SGM34MDS5NSS	MMD1P22-34027	SGM44MSCESS-250	MMP22-44SK030
SGM29FSCST-250	MMS22-29SL	SGM34MDS5NSS-250	MMD1P22-34028	SGM44MSCN	MMP22-44026
SGM29MDS5E	MMD1P22-29SK2	SGM34MDS5NSSJ	MMD1P22-34027H	SGM44MSCNJ	MMP22-44026H
SGM29MDS5E-250	MMD1P22-29SK	SGM34MDS5T	MMD1P22-34SL2	SGM44MSCNSS	MMP22-44027
SGM29MDS5E1J	MMD1P22-29SK2H	SGM34MDS5T-250	MMD1P22-34SL	SGM44MSCNSS-250	MMP22-44028
SGM29MDS5E1J-250	MMD1P22-29SKH	SGM34MSCE	MMP22-34SK2	SGM44MSCNSSJ	MMP22-44027H
SGM29MDS5ESS	MMD1P22-29SK2030	SGM34MSCE-250	MMP22-34SK	SGM44MSCT	MMP22-44SL2
SGM29MDS5ESS-250	MMD1P22-29SK030	SGM34MSCE1J	MMP22-34SK2H	SGM44MSCT-250	MMP22-44SL
SGM29MDS5N	MMD1P22-29026	SGM34MSCE1J-250	MMP22-34SKH	SGM50FDS5E	MMD1S22-50SK2
SGM29MDS5NJ	MMD1P22-29026H	SGM34MSCESS	MMP22-34SK2030	SGM50FDS5E-250	MMD1S22-50SK
SGM29MDS5NSS	MMD1P22-29027	SGM34MSCESS-250	MMP22-34SK030	SGM50FDS5E1J	MMD1S22-50SK2H
SGM29MDS5NSS-250	MMD1P22-29028	SGM34MSCN	MMP22-34026	SGM50FDS5E1J-250	MMD1S22-50SKH
SGM29MDS5NSSJ	MMD1P22-29027H	SGM34MSCNJ	MMP22-34026H	SGM50FDS5ESS	MMD1S22-50SK2030
SGM29MDS5T	MMD1P22-29SL2	SGM34MSCNSS	MMP22-34027	SGM50FDS5ESS-250	MMD1S22-50SK030
SGM29MDS5T-250	MMD1P22-29SL	SGM34MSCNSS-250	MMP22-34028	SGM50FDS5N	MMD1S22-50026
SGM29MSCE	MMP22-29SK2	SGM34MSCNSSJ	MMP22-34027H	SGM50FDS5NJ	MMD1S22-50026H
SGM29MSCE-250	MMP22-29SK	SGM34MSCT	MMP22-34SL2	SGM50FDS5NSS	MMD1S22-50027
SGM29MSCE1J	MMP22-29SK2H	SGM34MSCT-250	MMP22-34SL	SGM50FDS5NSS-250	MMD1S22-50028
SGM29MSCE1J-250	MMP22-29SKH	SGM44FDS5E	MMD1S22-44SK2	SGM50FDS5NSSJ	MMD1S22-50027H
SGM29MSCESS	MMP22-29SK2030	SGM44FDS5E-250	MMD1S22-44SK	SGM50FDS5T	MMD1S22-50SL2
SGM29MSCESS-250	MMP22-29SK030	SGM44FDS5E1J	MMD1S22-44SK2H	SGM50FDS5T-250	MMD1S22-50SL
SGM29MSCN	MMP22-29026	SGM44FDS5E1J-250	MMD1S22-44SKH	SGM50FSCSE	MMS22-50SK2
SGM29MSCNJ	MMP22-29026H	SGM44FDS5ESS	MMD1S22-44SK2030	SGM50FSCSE-250	MMS22-50SK
SGM29MSCNSS	MMP22-29027	SGM44FDS5ESS-250	MMD1S22-44SK030	SGM50FSCSE1J	MMS22-50SK2H
SGM29MSCNSS-250	MMP22-29028	SGM44FDS5N	MMD1S22-44026	SGM50FSCSE1J-250	MMS22-50SKH
SGM29MSCNSSJ	MMP22-29027H	SGM44FDS5NJ	MMD1S22-44026H	SGM50FSCSESS	MMS22-50SK2030
SGM29MSCT	MMP22-29SL2	SGM44FDS5NSS	MMD1S22-44027	SGM50FSCSESS-250	MMS22-50SK030
SGM29MSCT-250	MMP22-29SL	SGM44FDS5NSS-250	MMD1S22-44028	SGM50FSCSN	MMS22-50026
SGM34FDS5E	MMD1S22-34SK2	SGM44FDS5NSSJ	MMD1S22-44027H	SGM50FSCNJ	MMS22-50026H
SGM34FDS5E-250	MMD1S22-34SK	SGM44FDS5T	MMD1S22-44SL2	SGM50FSCNSS	MMS22-50027
SGM34FDS5E1J	MMD1S22-34SK2H	SGM44FDS5T-250	MMD1S22-44SL	SGM50FSCNSS-250	MMS22-50028
SGM34FDS5E1J-250	MMD1S22-34SKH	SGM44FSCSE	MMS22-44SK2	SGM50FSCNSSJ	MMS22-50027H
SGM34FDS5ESS	MMD1S22-34SK2030	SGM44FSCSE-250	MMS22-44SK	SGM50FSCST	MMS22-50SL2
SGM34FDS5ESS-250	MMD1S22-34SK030	SGM44FSCSE1J	MMS22-44SK2H	SGM50FSCST-250	MMS22-50SL
SGM34FDS5N	MMD1S22-34026	SGM44FSCSN	MMS22-44SKH	SGM50MDS5E	MMD1P22-50SK2
SGM34FDS5NJ	MMD1S22-34026H	SGM44FSCSESS	MMS22-44SK2030	SGM50MDS5E-250	MMD1P22-50SK
SGM34FDS5NSS	MMD1S22-34027	SGM44FSCSESS-250	MMS22-44SK030	SGM50MDS5E1J	MMD1P22-50SK2H
SGM34FDS5NSS-250	MMD1S22-34028	SGM44FSCSN	MMS22-44026	SGM50MDS5E1J-250	MMD1P22-50SKH
SGM34FDS5NSSJ	MMD1S22-34027H	SGM44FSCSNJ	MMS22-44026H	SGM50MDS5ESS	MMD1P22-50SK2030
SGM34FDS5T	MMD1S22-34SL2	SGM44FSCNSS	MMS22-44027	SGM50MDS5ESS-250	MMD1P22-50SK030
SGM34FDS5T-250	MMD1S22-34SL	SGM44FSCNSS-250	MMS22-44028	SGM50MDS5N	MMD1P22-50026
SGM34FSCSE	MMS22-34SK2	SGM44FSCNSSJ	MMS22-44027H	SGM50MDS5NJ	MMD1P22-50026H
SGM34FSCSE-250	MMS22-34SK	SGM44FSCST	MMS22-44SL2	SGM50MDS5NSS	MMD1P22-50027
SGM34FSCSE1J	MMS22-34SK2H	SGM44FSCST-250	MMS22-44SL	SGM50MDS5NSS-250	MMD1P22-50028
SGM34FSCSE1J-250	MMS22-34SKH	SGM44MDS5E	MMD1P22-44SK2	SGM50MDS5NSSJ	MMD1P22-50027H
SGM34FSCSESS	MMS22-34SK2030	SGM44MDS5E-250	MMD1P22-44SK	SGM50MDS5T	MMD1P22-50SL2
SGM34FSCSESS-250	MMS22-34SK030	SGM44MDS5E1J	MMD1P22-44SK2H	SGM50MDS5T-250	MMD1P22-50SL
SGM34FSCN	MMS22-34026	SGM44MDS5E1J-250	MMD1P22-44SKH	SGM50MSCE	MMP22-50SK2



# Cross Reference - Positronics

Positronics/Vishay Dale Rack and Panel Connectors -  
Microminiature, Subminiature, Miniature

Vishay Dale

<b>POSITRONICS</b>	<b>VISHAY DALE</b>	<b>POSITRONICS</b>	<b>VISHAY DALE</b>	<b>POSITRONICS</b>	<b>VISHAY DALE</b>
SGM34FSCNJ	MMS22-34026H	SGM44MDS5ESS	MMD1P22-44SK2030	SGM50MSCE-250	MMP22-50SK
SGM34FSCNSS	MMS22-34027	SGM44MDS5ESS-250	MMD1P22-44SK030	SGM50MSCE1J	MMP22-50SK2H
SGM34FSCNSS-250	MMS22-34028	SGM44MDS5N	MMD1P22-44026	SGM50MSCE1J-250	MMP22-50SKH
SGM34FSCNSSJ	MMS22-34027H	SGM44MDS5NJ	MMD1P22-44026H	SGM50MSCCESS	MMP22-50SK2030
SGM34FSCT	MMS22-34SL2	SGM44MDS5NSS	MMD1P22-44027	SGM50MSCCESS-250	MMP22-50SK030
SGM34FSCT-250	MMS22-34SL	SGM44MDS5NSSJ	MMD1P22-44027H	SGM50MSCN	MMP22-50026
SGM34MDS5E	MMD1P22-34SK2	SGM44MDS5T	MMD1P22-44SL2	SGM50MSCNJ	MMP22-50026H
SGM34MDS5E-250	MMD1P22-34SK	SGM44MDS5T-250	MMD1P22-44SL	SGM50MSCNSS	MMP22-50027
SGM34MDS5E1J	MMD1P22-34SK2H	SGM44MSCE	MMP22-44SK2	SGM50MSCNSS-250	MMP22-50028
SGM34MDS5E1J-250	MMD1P22-34SKH	SLM7FDS5NSS	MMD1S24-7027	SGM50MSCNSSJ	MMP22-50027H
SGM50MSCT	MMP22-50SL2	SLM7FDS5NSS-250	MMD1S24-7028	SLM9FSCCESS-250	MMS24-9SK030
SGM50MSCT-250	MMP22-50SL	SLM7FDS5NSSJ	MMD1S24-7027H	SLM9FSCN	MMS24-9026
SLM5FDS5E	MMD1S24-5SK2	SLM7FDS5T	MMD1S24-7SL2	SLM9FSCNJ	MMS24-9026H
SLM5FDS5E-250	MMD1S24-5SK	SLM7FDS5T-250	MMD1S24-7SL	SLM9FSCNSS	MMS24-9027
SLM5FDS5E1J	MMD1S24-5SK2H	SLM7FDS5T-250	MMD1S24-7SL	SLM9FSCNSS-250	MMP22-50028
SLM5FDS5E1J-250	MMD1S24-5SKH	SLM7FSCE	MMS24-7SK2	SLM9FSCNSSJ	MMS24-9027H
SLM5FDS5ESS	MMD1S24-5SK2030	SLM7FSCE-250	MMS24-7SK	SLM9FSCT	MMS24-9SL2
SLM5FDS5ESS-250	MMD1S24-5SK030	SLM7FSCE1J	MMS24-7SK2H	SLM9FSCT-250	MMS24-9SL
SLM5FDS5N	MMD1S24-5026	SLM7FSCE1J-250	MMS24-7SKH	SLM9MDS5E	MMD1P24-9SK2
SLM5FDS5NJ	MMD1S24-5026H	SLM7FSCESS	MMS24-7SK2030	SLM9MDS5E-250	MMD1P24-9SK
SLM5FDS5NSS	MMD1S24-5027	SLM7FSCESS-250	MMS24-7SK030	SLM9MDS5E1J	MMD1P24-9SK2H
SLM5FDS5NSS-250	MMD1S24-5028	SLM7FSCN	MMS24-7026	SLM9MDS5E1J-250	MMD1P24-9SKH
SLM5FDS5NSSJ	MMD1S24-5027H	SLM7FSCNJ	MMS24-7026H	SLM9MDS5ESS	MMD1P24-9SK2030
SLM5FDS5T	MMD1S24-5SL2	SLM7FSCNSS	MMS24-7027	SLM9MDS5ESS-250	MMD1P24-9SK030
SLM5FDS5T-250	MMD1S24-5SL	SLM7FSCNSS-250	MMS24-7028	SLM9MDS5N	MMD1P24-9026
SLM5FSCE	MMS24-5SK2	SLM7FSCNSSJ	MMS24-7027H	SLM9MDS5NJ	MMD1P24-9026H
SLM5FSCE-250	MMS24-5SK	SLM7FSCT	MMS24-7SL2	SLM9MDS5NSS	MMD1P24-9027
SLM5FSCE1J	MMS24-5SK2H	SLM7FSCT-250	MMS24-7SL	SLM9MDS5NSS-250	MMD1P24-9028
SLM5FSCE1J-250	MMS24-5SKH	SLM7MDS5E	MMD1P24-7SK2	SLM9MDS5NSSJ	MMD1P24-9027H
SLM5FSCESS	MMS24-5SK2030	SLM7MDS5E-250	MMD1P24-7SK	SLM9MDS5T	MMD1P24-9SL2
SLM5FSCESS-250	MMS24-5SK030	SLM7MDS5E1J	MMD1P24-7SK2H	SLM9MDS5T-250	MMD1P24-9SL
SLM5FSCN	MMS24-5026	SLM7MDS5E1J-250	MMD1P24-7SKH	SLM9MSCE	MMP24-9SK2
SLM5FSCNJ	MMS24-5026H	SLM7MDS5ESS	MMD1P24-7SK2030	SLM9MSCE-250	MMP24-9SK
SLM5FSCNSS	MMS24-5027	SLM7MDS5NSS-250	MMD1P24-7SK030	SLM9MSCE1J	MMP24-9SK2H
SLM5FSCNSS-250	MMS24-5028	SLM7MDS5N	MMD1P24-7026	SLM9MSCE1J-250	MMP24-9SKH
SLM5FSCNSSJ	MMS24-5027H	SLM7MDS5NJ	MMD1P24-7026H	SLM9MSCCESS	MMP24-9SK2030
SLM5FSCT	MMS24-5SL2	SLM7MDS5NSS	MMD1P24-7027	SLM9MSCCESS-250	MMP24-9SK030
SLM5FSCT-250	MMS24-5SL	SLM7MDS5NSS-250	MMD1P24-7028	SLM9MSCN	MMP24-9026
SLM5MDS5E	MMD1P24-5SK2	SLM7MDS5NSSJ	MMD1P24-7027H	SLM9MSCNJ	MMP24-9026H
SLM5MDS5E-250	MMD1P24-5SK	SLM7MDS5T	MMD1P24-7SL2	SLM9MSCNSS	MMP24-9027
SLM5MDS5E1J	MMD1P24-5SK2H	SLM7MSCT-250	MMD1P24-7SL	SLM9MSCNSS-250	MMP24-9028
SLM5MDS5E1J-250	MMD1P24-5SKH	SLM7MSCE	MMP24-7SK2	SLM9MSCNSSJ	MMP24-9027H
SLM5MDS5ESS	MMD1P24-5SK2030	SLM7MSCE-250	MMP24-7SK	SLM9MSCT	MMP24-9SL2
SLM5MDS5ESS-250	MMD1P24-5SK030	SLM7MSCE1J	MMP24-7SK2H	SLM9MSCT-250	MMP24-9SL
SLM5MDS5N	MMD1P24-5026	SLM7MSCE1J-250	MMP24-7SKH	SLM11FDS5E	MMD1S24-11SK2
SLM5MDS5NJ	MMD1P24-5026H	SLM7MSCCESS	MMP24-7SK2030	SLM11DS5E-250	MMD1S24-11SK
SLM5MDS5NSS	MMD1P24-5027	SLM7MSCCESS-250	MMP24-7SK030	SLM11FDS5E1J	MMD1S24-11SK2H
SLM5MDS5NSS-250	MMD1P24-5028	SLM7MSCN	MMP24-7026	SLM11FDS5E1J-250	MMD1S24-11SKH
SLM5MDS5NSSJ	MMD1P24-5027H	SLM7MSCNJ	MMP24-7026H	SLM11FDS5ESS	MMD1S24-11SK2030
SLM5MDS5T	MMD1P24-5SL2	SLM7MSCNSS	MMP24-7027	SLM11FDS5ESS-250	MMD1S24-11SK030
SLM5MDS5T-250	MMD1P24-5SL	SLM7MSCNSS-250	MMP24-7028	SLM11FDS5N	MMD1S24-11026
SLM5MSCE	MMP24-5SK2	SLM7MSCNSSJ	MMP24-7027H	SLM11FDS5NJ	MMD1S24-11026H
SLM5MSCE-250	MMP24-5SK	SLM7MSCT	MMP24-7SL2	SLM11FDS5NSS	MMD1S24-11027
SLM5MSCE1J	MMP24-5SK2H	SLM7MSCT-250	MMP24-7SL	SLM11FDS5NSS-250	MMD1S24-11028
SLM5MSCE1J-250	MMP24-5SKH	SLM9FDS5E	MMD1S24-9SK2	SLM11FDS5NSSJ	MMD1S24-11027H
SLM5MSCCESS	MMP24-5SK2030	SLM9FDS5E-250	MMD1S24-9SK	SLM11FDS5T	MMD1S24-11SL2
SLM5MSCCESS-250	MMP24-5SK030	SLM9FDS5E1J	MMD1S24-9SK2H	SLM11FDS5T-250	MMD1S24-11SL
SLM5MSCN	MMP24-5026	SLM9FDS5E1J-250	MMD1S24-9SKH	SLM11FSCE	MMS24-11SK2
SLM5MSCNJ	MMP24-5026H	SLM9FDS5ESS	MMD1S24-9SK2030	SLM11FSCE-250	MMS24-11SK
SLM5MSCNSS	MMP24-5027	SLM9FDS5ESS-250	MMD1S24-9SK030	SLM11FSCE1J	MMS24-11SK2H

# Cross Reference - Positronics



Vishay Dale Positronics/Vishay Dale Rack and Panel Connectors -  
Microminiature, Subminiature, Miniature

POSITRONICS	VISHAY DALE	POSITRONICS	VISHAY DALE	POSITRONICS	VISHAY DALE
SLM5MSCNSS-250	MMP24-5028	SLM9FDS5N	MMD1S24-9026	SLM11FSC1J-250	MMS24-11SKH
SLM5MSCNSSJ	MMP24-5027H	SLM9FDS5NJ	MMD1S24-9026H	SLM11FSC2ESS	MMS24-11SK2030
SLM5MSCT	MMP24-5SL2	SLM9FDS5NSS	MMD1S24-9027	SLM11FSC2ESS-250	MMS24-11SK030
SLM5MSCT-250	MMP24-5SL	SLM9FDS5NSS-250	MMD1S24-9028	SLM11FSC3CN	MMS24-11026
SLM7FDS5E	MMD1S24-7SK2	SLM9FDS5NSSJ	MMD1S24-9027H	SLM11FSC3CNJ	MMS24-11026H
SLM7FDS5E-250	MMD1S24-7SK	SLM9FDS5ST	MMD1S24-9SL2	SLM11FSC3NSS	MMS24-11027
SLM7FDS5E1J	MMD1S24-7SK2H	SLM9FDS5T-250	MMD1S24-9SL	SLM11FSC3NSS-250	MMS24-11028
SLM7FDS5E1J-250	MMD1S24-7SKH	SLM9FDS5T	MMS24-9SK2	SLM11FSC3NSSJ	MMS24-11027H
SLM7FDS5ESS	MMD1S24-7SK2030	SLM9FDS5T-250	MMS24-9SK	SLM11FSC4T	MMS24-11SL2
SLM7FDS5ESS-250	MMD1S24-7SK030	SLM9FDS5T	MMS24-9SK2H	SLM11FSC4T-250	MMS24-11SL
SLM7FDS5N	MMD1S24-7026	SLM9FDS5T-250	MMS24-9SKH	SLM11MDS5E	MMD1P24-11SK2
SLM7FDS5NJ	MMD1S24-7026H	SLM9FDS5T-250	MMS24-9SK2030	SLM11MDS5E-250	MMD1P24-11SK
SLM11MDS5E1J	MMD1P24-11SK2H	SLM9FDS5T-250	MMD1P24-14SL	SLM20MSCNSS-250	MMP24-20028
SLM11MDS5E1J-250	MMD1P24-11SKH	SLM9FDS5T-250	MMP24-14SK2	SLM20MSCNSSJ	MMP24-20027H
SLM11MDS5ESS	MMD1P24-11SK2030	SLM9FDS5T-250	MMP24-14SK	SLM20MSCT	MMP24-20SL2
SLM11MDS5ESS-250	MMD1P24-11SK030	SLM9FDS5T-250	MMP24-14SK2H	SLM20MSCT-250	MMP24-20SL
SLM11MDS5N	MMD1P24-11026	SLM9FDS5T-250	MMP24-14SKH	SLM26FDS5E	MMD1S24-26SK2
SLM11MDS5NJ	MMD1P24-11026H	SLM9FDS5T-250	MMP24-14SK2030	SLM26FDS5E-250	MMD1S24-26SK
SLM11MDS5NSS	MMD1P24-11027	SLM9FDS5T-250	MMP24-14SK030	SLM26FDS5E1J	MMD1S24-26SK2H
SLM11MDS5NSS-250	MMD1P24-11028	SLM9FDS5T-250	MMP24-14026	SLM26FDS5E1J-250	MMD1S24-26SKH
SLM11MDS5NSSJ	MMD1P24-11027H	SLM14MSCNJ	MMP24-14026H	SLM26FDS5ESS	MMD1S24-26SK2030
SLM11MDS5T	MMD1P24-11SL2	SLM14MSCNSS	MMP24-14027	SLM26FDS5ESS-250	MMD1S24-26SK030
SLM11MDS5T-250	MMD1P24-11SL	SLM14MSCNSS-250	MMP24-14028	SLM26FDS5N	MMD1S24-26026
SLM11MSCE	MMP24-11SK2	SLM14MSCNSSJ	MMP24-14027H	SLM26FDS5NJ	MMD1S24-26026H
SLM11MSCE-250	MMP24-11SK	SLM14MSCNSSJ	MMP24-14SL2	SLM26FDS5NSS	MMD1S24-26027
SLM11MSCE1J	MMP24-11SK2H	SLM14MSCT	MMP24-14SL	SLM26FDS5NSS-250	MMD1S24-26028
SLM11MSCE1J-250	MMP24-11SKH	SLM14MSCT-250	MMD1S24-20SK2	SLM26FDS5NSSJ	MMD1S24-26027H
SLM11MSCESS	MMP24-11SK2030	SLM20FDS5E	MMD1S24-20SK	SLM26FDS5T	MMD1S24-26SL2
SLM11MSCESS-250	MMP24-11SK030	SLM20FDS5E-250	MMD1S24-20SK2H	SLM26FDS5T-250	MMD1S24-26SL
SLM11MSCN	MMP24-11026	SLM20FDS5E1J	MMD1S24-20SKH	SLM26FDS5T-250	MMS24-26SK2
SLM11MSCNJ	MMP24-11026H	SLM20FDS5E1J-250	MMD1S24-20SK2030	SLM26FDS5T-250	MMS24-26SK
SLM11MSCNSS	MMP24-11027	SLM20FDS5ESS	MMD1S24-20SK030	SLM26FDS5T-250	MMS24-26SK2H
SLM11MSCNSS-250	MMP24-11028	SLM20FDS5ESS-250	MMD1S24-20SK030	SLM26FDS5T-250	MMS24-26SKH
SLM11MSCNSSJ	MMP24-11027H	SLM20FDS5N	MMD1S24-20026	SLM26FDS5T-250	MMS24-26SK2030
SLM11MSCT	MMP24-11SL2	SLM20FDS5NJ	MMD1S24-20026H	SLM26FDS5T-250	MMS24-26SK030
SLM11MSCT-250	MMP24-11SL	SLM20FDS5NSS	MMD1S24-20027	SLM26FDS5T-250	MMS24-26026
SLM14FDS5E	MMD1S24-14SK2	SLM20FDS5NSS-250	MMD1S24-20028	SLM26FDS5T-250	MMS24-26026H
SLM14FDS5E-250	MMD1S24-14SK	SLM20FDS5NSSJ	MMD1S24-20027H	SLM26FDS5T-250	MMS24-26027
SLM14FDS5E1J	MMD1S24-14SK2H	SLM20FDS5ST	MMD1S24-200SL2	SLM26FDS5T-250	MMS24-26027H
SLM14FDS5E1J-250	MMD1S24-14SKH	SLM20FDS5T-250	MMD1S24-20SL	SLM26FDS5T-250	MMS24-26028
SLM14FDS5ESS	MMD1S24-14SK2030	SLM20FDS5T	MMS24-20SK2	SLM26FDS5T-250	MMS24-26027H
SLM14FDS5ESS-250	MMD1S24-14SK030	SLM20FDS5T-250	MMS24-20SK2H	SLM26FDS5T-250	MMS24-26026
SLM14FDS5N	MMD1S24-14026	SLM20FDS5T-250	MMS24-20SKH	SLM26FDS5T-250	MMD1P24-26SK2
SLM14FDS5NJ	MMD1S24-14026H	SLM20FDS5T-250	MMS24-20SK2030	SLM26FDS5T-250	MMD1P24-26SK2H
SLM14FDS5NSS	MMD1S24-14027	SLM20FDS5T-250	MMS24-20SK030	SLM26FDS5T-250	MMD1P24-26SKH
SLM14FDS5NSS-250	MMD1S24-14028	SLM20FDS5T-250	MMS24-20026	SLM26FDS5T-250	MMD1P24-26SK2030
SLM14FDS5NSSJ	MMD1S24-14027H	SLM20FDS5T-250	MMS24-20026H	SLM26FDS5T-250	MMD1P24-26SK030
SLM14FDS5T	MMD1S24-14SL2	SLM20FDS5T-250	MMS24-20027	SLM26FDS5T-250	MMD1P24-26SK2030
SLM14FDS5T-250	MMD1S24-14SL	SLM20FDS5T-250	MMS24-20028	SLM26FDS5T-250	MMD1P24-26026
SLM14FSCE	MMS24-14SK2	SLM20FDS5T-250	MMS24-20027H	SLM26FDS5T-250	MMD1P24-26026H
SLM14FSCE-250	MMS24-14SK	SLM20FDS5T-250	MMS24-20SL2	SLM26FDS5T-250	MMD1P24-26027
SLM14FSCE1J	MMS24-14SK2H	SLM20FDS5T-250	MMS24-20SL	SLM26FDS5T-250	MMD1P24-26028
SLM14FSCE1J-250	MMS24-14SKH	SLM20FDS5T-250	MMD1P24-20SK2	SLM26FDS5T-250	MMD1P24-26027H
SLM14FSCESS	MMS24-14SK2030	SLM20FDS5T-250	MMD1P24-20SK	SLM26FDS5T-250	MMD1P24-26SL2
SLM14FSCESS-250	MMS24-14SK030	SLM20FDS5T-250	MMD1P24-20SK2H	SLM26FDS5T-250	MMD1P24-26SL
SLM14FSCN	MMS24-14026	SLM20FDS5T-250	MMD1P24-20SKH	SLM26FDS5T-250	MMP24-26SK2
SLM14FSCNJ	MMS24-14026H	SLM20FDS5T-250	MMD1P24-20SK2030	SLM26FDS5T-250	MMP24-26SK
SLM14FSCNSS	MMS24-14027	SLM20FDS5T-250	MMD1P24-20SK030	SLM26FDS5T-250	MMP24-26SK2H
SLM14FSCNSS-250	MMS24-14028	SLM20FDS5T-250	MMD1P24-20026	SLM26FDS5T-250	MMP24-26SKH
SLM14FSCNSSJ	MMS24-14027H	SLM20FDS5T-250	MMD1P24-20026H	SLM26FDS5T-250	MMP24-26SK2030



# Cross Reference - Positronics

Positronics/Vishay Dale Rack and Panel Connectors -  
Microminiature, Subminiature, Miniature

Vishay Dale

POSITRONICS	VISHAY DALE	POSITRONICS	VISHAY DALE	POSITRONICS	VISHAY DALE
SLM14FSCT	MMS24-14SL2	SLM20MDS5NSS	MMD1P24-20027	SLM26MSCES-250	MMP24-26SK030
SLM14FSCT-250	MMS24-14SL	SLM20MDS5NSS-250	MMD1P24-20028	SLM26MSCN	MMP24-26026
SLM14MDS5E	MMD1P24-14SK2	SLM20MDS5NSSJ	MMD1P24-20027H	SLM26MSCNJ	MMP24-26026H
SLM14MDS5E-250	MMD1P24-14SK	SLM20MDS5T	MMD1P24-20SL2	SLM26MSCNSS	MMP24-26027
SLM14MDS5E1J	MMD1P24-14SK2H	SLM20MDS5T-250	MMD1P24-20SL	SLM26MSCNSS-250	MMP24-26028
SLM14MDS5E1J-250	MMD1P24-14SKH	SLM20MSCE	MMP24-20SK2	SLM26MSCNSSJ	MMP24-26027H
SLM14MDS5ESS	MMD1P24-14SK2030	SLM20MSCE-250	MMP24-20SK	SLM26MSCT	MMP24-26SL2
SLM14MDS5ESS-250	MMD1P24-14SK030	SLM20MSCE1J	MMP24-20SK2H	SLM26MSCT-250	MMP24-26SL
SLM14MDS5N	MMD1P24-14026	SLM20MSCE1J-250	MMP24-20SKH	SLM29FDS5E	MMD1S24-29SK2
SLM14MDS5NJ	MMD1P24-14026H	SLM20MSCESS	MMP24-20SK2030	SLM29FDS5E-250	MMD1S24-29SK
SLM14MDS5NSS	MMD1P24-14027	SLM20MSCESS-250	MMP24-20SK030	SLM29FDS5E1J	MMD1S24-29SK2H
SLM14MDS5NSS-250	MMD1P24-14028	SLM20MSCN	MMP24-20026	SLM29FDS5E1J-250	MMD1S24-29SKH
SLM14MDS5NSSJ	MMD1P24-14027H	SLM20MSCNJ	MMP24-20026H	SLM29FDS5ESS	MMD1S24-29SK2030
SLM14MDS5T	MMD1P24-14SL2	SLM20MSCNSS	MMP24-20027	SLM29FDS5ESS-250	MMD1S24-29SK030
SLM29FDS5N	MMD1S24-29026	SLM34FSC1J-250	MMS24-34SKH	SLM44MDS5E	MMD1P24-44SK2
SLM29FDS5NJ	MMD1S24-29026H	SLM34FSCCESS	MMS24-34SK2030	SLM44MDS5E-250	MMD1P24-44SK
SLM29FDS5NSS	MMD1S24-29027	SLM34FSCCESS-250	MMS24-34SK030	SLM44MDS5E1J	MMD1P24-44SK2H
SLM29FDS5NSS-250	MMD1S24-29028	SLM34FSCN	MMS24-34026	SLM44MDS5E1J-250	MMD1P24-44SKH
SLM29FDS5NSSJ	MMD1S24-29027H	SLM34FSCNJ	MMS24-34026H	SLM44MDS5ESS	MMD1P24-44SK2030
SLM29FDS5T	MMD1S24-29SL2	SLM34FSCNSS	MMS24-34027	SLM44MDS5ESS-250	MMD1P24-44SK030
SLM29FDS5T-250	MMD1S24-29SL	SLM34FSCNSS-250	MMS24-34028	SLM44MDS5N	MMD1P24-44026
SLM29FSCE	MMS24-29SK2	SLM34FSCNSSJ	MMS24-34027H	SLM44MDS5NJ	MMD1P24-44026H
SLM29FSCE-250	MMS24-29SK	SLM34FSCT	MMS24-34SL2	SLM44MDS5NSS	MMD1P24-44027
SLM29FSCE1J	MMS24-29SK2H	SLM34FSCT-250	MMS24-34SL	SLM44MDS5NSS-250	MMD1P24-44028
SLM29FSCE1J-250	MMS24-29SKH	SLM34MDS5E	MMD1P24-34SK2	SLM44MDS5NSSJ	MMD1P24-44027H
SLM29FSCESS	MMS24-29SK2030	SLM34MDS5E-250	MMD1P24-34SK	SLM44MDS5T	MMD1P24-44SL2
SLM29FSCESS-250	MMS24-29SK030	SLM34MDS5E1J	MMD1P24-34SK2H	SLM44MDS5T-250	MMD1P24-44SL
SLM29FSCN	MMS24-29026	SLM34MDS5E1J-250	MMD1P24-34SKH	SLM44MSCE	MMP24-44SK
SLM29FSCNJ	MMS24-29026H	SLM34MDS5ESS	MMD1P24-34SK2030	SLM44MSCE-250	MMP24-44SK
SLM29FSCNSS	MMS24-29027	SLM34MDS5ESS-250	MMD1P24-34SK030	SLM44MSCE1J	MMP24-44SK2H
SLM29FSCNSS-250	MMS24-29028	SLM34MDS5N	MMD1P24-34026	SLM44MSCE1J-250	MMP24-44SKH
SLM29FSCNSSJ	MMS24-29027H	SLM34MDS5NJ	MMD1P24-34026H	SLM44MSCESS	MMP24-44SK2030
SLM29FSCT	MMS24-29SL2	SLM34MDS5NSS	MMD1P24-34027	SLM44MSCESS-250	MMP24-44SK030
SLM29FSCT-250	MMS24-29SL	SLM34MDS5NSS-250	MMD1P24-34028	SLM44MSCN	MMP24-44026
SLM29MDS5E	MMD1P24-29SK2	SLM34MDS5NSSJ	MMD1P24-34027H	SLM44MSCNJ	MMP24-44026H
SLM29MDS5E-250	MMD1P24-29SK	SLM34MDS5T	MMD1P24-34SL2	SLM44MSCNSS	MMP24-44027
SLM29MDS5E1J	MMD1P24-29SK2H	SLM34MDS5T-250	MMD1P24-34SL	SLM44MSCNSS-250	MMP24-44028
SLM29MDS5E1J-250	MMD1P24-29SKH	SLM34MSCE	MMP24-34SK2	SLM44MSCNSSJ	MMP24-44027H
SLM29MDS5ESS	MMD1P24-29SK2030	SLM34MSCE-250	MMP24-34SK	SLM44MSCT	MMP24-44SL2
SLM29MDS5ESS-250	MMD1P24-29SK030	SLM34MSCE1J	MMP24-34SK2H	SLM44MSCT-250	MMP24-44SL
SLM29MDS5N	MMD1P24-29026	SLM34MSCE1J-250	MMP24-34SKH	SLM50FDS5E	MMD1S24-50SK2
SLM29MDS5NJ	MMD1P24-29026H	SLM34MSCESS	MMP24-34SK2030	SLM50FDS5E-250	MMD1S24-50SK
SLM29MDS5NSS	MMD1P24-29027	SLM34MSCESS-250	MMP24-34SK030	SLM50FDS5E1J	MMD1S24-50SK2H
SLM29MDS5NSS-250	MMD1P24-29028	SLM34MSCN	MMP24-34026	SLM50FDS5E1J-250	MMD1S24-50SKH
SLM29MDS5NSSJ	MMD1P24-29027H	SLM34MSCNJ	MMP24-34026H	SLM50FDS5ESS	MMD1S24-50SK2030
SLM29MDS5T	MMD1P24-29SL2	SLM34MSCNSS	MMP24-34027	SLM50FDS5ESS-250	MMD1S24-50SK030
SLM29MDS5T-250	MMD1P24-29SL	SLM34MSCNSS-250	MMP24-34028	SLM50FDS5N	MMD1S24-50026
SLM29MSCE	MMP24-29SK2	SLM34MSCNSSJ	MMP24-34027H	SLM50FDS5NJ	MMD1S24-50026H
SLM29MSCE-250	MMP24-29SK	SLM34MSCT	MMP24-34SL2	SLM50FDS5NSS	MMD1S24-50027
SLM29MSCE1J	MMP24-29SK2H	SLM34MSCT-250	MMP24-34SL	SLM50FDS5NSS-250	MMD1S24-50028
SLM29MSCE1J-250	MMP24-29SKH	SLM44FDS5E	MMD1S24-44SK2	SLM50FDS5NSSJ	MMD1S24-50027H
SLM29MSCESS	MMP24-29SK2030	SLM44FDS5E-250	MMD1S24-44SK	SLM50FDS5T	MMD1S24-50SL2
SLM29MSCESS-250	MMP24-29SK030	SLM44FDS5E1J	MMD1S24-44SK2H	SLM50FDS5T-250	MMD1S24-50SL
SLM29MSCN	MMP24-29026	SLM44FDS5E1J-250	MMD1S24-44SKH	SLM50FSCE	MMS24-50SK2
SLM29MSCNJ	MMP24-29026H	SLM44FDS5ESS	MMD1S24-44SK2030	SLM50FSCE-250	MMS24-50SK
SLM29MSCNSS	MMP24-29027	SLM44FDS5ESS-250	MMD1S24-44SK030	SLM50FSCE1J	MMS24-50SK2H
SLM29MSCNSS-250	MMP24-29028	SLM44FDS5N	MMD1S24-44026	SLM50FSCE1J-250	MMS24-50SKH
SLM29MSCNSSJ	MMP24-29027H	SLM44FDS5NJ	MMD1S24-44026H	SLM50FSCESS	MMS24-50SK2030
SLM29MSCT	MMP24-290SL2	SLM44FDS5NSS	MMD1S24-44027	SLM50FSCESS-250	MMS24-50SK030
SLM29MSCT-250	MMP24-29SL	SLM44FDS5NSS-250	MMD1S24-44028	SLM50FSCN	MMS24-50026

# Cross Reference - Positronics



Vishay Dale Positronics/Vishay Dale Rack and Panel Connectors -  
Microminiature, Subminiature, Miniature

<b>POSITRONICS</b>	<b>VISHAY DALE</b>	<b>POSITRONICS</b>	<b>VISHAY DALE</b>	<b>POSITRONICS</b>	<b>VISHAY DALE</b>
SLM34FDS5E	MMD1S24-34SK2	SLM44FDS5NSSJ	MMD1S24-44027H	SLM50FSCNJ	MMS24-50026H
SLM34FDS5E-250	MMD1S24-34SK	SLM44FDS5T	MMD1S24-44SL2	SLM50FSCNSS	MMS24-50027
SLM34FDS5E1J	MMD1S24-34SK2H	SLM44FDS5T-250	MMD1S24-44SL	SLM50FSCNSS-250	MMS24-50028
SLM34FDS5E1J-250	MMD1S24-34SKH	SLM44FSCE	MMS24-44SK2	SLM50FSCNSSJ	MMS24-50027H
SLM34FDS5ESS	MMD1S24-34SK2030	SLM44FSCE-250	MMS24-44SK	SLM50FSCT	MMS24-50SL2
SLM34FDS5ESS-250	MMD1S24-34SK030	SLM44FSCE1J	MMS24-44SK2H	SLM50FSCT-250	MMS24-50SL
SLM34FDS5N	MMD1S24-34026	SLM44FSCE1J-250	MMS24-44SKH	SLM50MDS5E	MMD1P24-50SK2
SLM34FDS5NJ	MMD1S24-34026H	SLM44FSCESS	MMS24-44SK2030	SLM50MDS5E-250	MMD1P24-50SK
SLM34FDS5NSS	MMD1S24-34027	SLM44FSCESS-250	MMS24-44SK030	SLM50MDS5E1J	MMD1P24-50SK2H
SLM34FDS5NSS-250	MMD1S24-34028	SLM44FSCN	MMS24-44026	SLM50MDS5E1J-250	MMD1P24-50SKH
SLM34FDS5NSSJ	MMD1S24-34027H	SLM44FSCNJ	MMS24-44026H	SLM50MDS5ESS	MMD1P24-50SK2030
SLM34FDS5T	MMD1S24-34SL2	SLM44FSCNSS	MMS24-44027	SLM50MDS5ESS-250	MMD1P24-50SK030
SLM34FDS5T-250	MMD1S24-34SL	SLM44FSCNSS-250	MMS24-44028	SLM50MDS5N	MMD1P24-50026
SLM34FSCE	MMS24-34SK2	SLM44FSCNSSJ	MMS24-44027H	SLM50MDS5NJ	MMD1P24-50026H
SLM34FSCE-250	MMS24-34SK	SLM44FSCT	MMS24-44SL2	SLM50MDS5NSS	MMD1P24-50027
SLM34FSCE1J	MMS24-34SK2H	SLM44FSCT-250	MMS24-44SL	SLM50MDS5NSS-250	MMD1P24-50028
SLM50MDS5NSSJ	MMD1P24-50027H	SLM50MSCE1J-250	MMP24-50SKH	SLM50MSCNSS	MMP24-50027
SLM50MDS5T	MMD1P24-50SL2	SLM50MSCESS	MMP24-50SK2030	SLM50MSCNSS-250	MMP24-50028
SLM50MDS5T-250	MMD1P24-50SL	SLM50MSCESS-250	MMP24-50SK030	SLM50MSCNSSJ	MMP24-50027H
SLM50MSCE	MMP24-50SK2	SLM50MSCN	MMP24-50026	SLM50MSCT	MMP24-50SL2
SLM50MSCE-250	MMP24-50SK	SLM50MSCNJ	MMP24-50026H	SLM50MSCT-250	MMP24-50SL
SLM50MSCE1J	MP24-50SK2H				

## SIDE MOUNTS

<b>POSITRONICS</b>	<b>VISHAY DALE</b>	<b>POSITRONICS</b>	<b>VISHAY DALE</b>	<b>POSITRONICS</b>	<b>VISHAY DALE</b>
GF-1F-1MA	G20P-A	GF-3F-1MB	WA20S-ACD	GF-3M-1FC	WA20P-ABD
GF-1M-1FA	G20S-A	GF-3F-1MC	WA20S-ABD	GF-3M-1FD	WA20P-ABC
GF-2F	G20S-AB	GF-3F-1MD	WA20S-ABC	GF-4M	WA20P-ABCD
GF-2M	G20P-AB	GF-3M-1FA	WA20P-BCD	GF-4F	WA20S-ABCD
GF-3F-1MA	WA20S-BCD	GF-3M-1FB	WA20P-ACD		





U.S. Components/Vishay Dale Rack and Panel Connectors - Microminiature, Subminiature, Miniature

Table with 6 columns: U.S. COMPONENTS, VISHAY DALE, U.S. COMPONENTS, VISHAY DALE, U.S. COMPONENTS, VISHAY DALE. It lists various connector models and their corresponding Vishay Dale part numbers.

# Cross Reference - U.S. Components



Vishay Dale

U.S. Components/Vishay Dale Rack and Panel  
Connectors - Microminiature, Subminiature, Miniature

U.S. COMPONENTS	VISHAY DALE	U.S. COMPONENTS	VISHAY DALE	U.S. COMPONENTS	VISHAY DALE
UM1-9F1KL	MMS22-9SK2030	UM1-11M1KL	MMP22-11SK2030	UM1-20F1KL	MMS22-20SK2030
UM1-9F1KL-DS	MMD1S22-9SK2030	UM1-11M1KL-DS	MMD1P22-11SK2030	UM1-20F1KL-DS	MMD1S22-20SK2030
UM1-9F1SL	MMS22-9SL2	UM1-11M1SL	MMP22-11SL2	UM1-20F1SL	MMS22-20SL2
UM1-9F1SL-DS	MMD1S22-9SL2	UM1-11M1SL-DS	MMD1P22-11SL2	UM1-20F1SL-DS	MMD1S22-20SL2
UM1-9F2HRSL	MMS22-9SKH	UM1-11M2HRSL	MMP22-11SKH	UM1-20F2HRSL	MMS22-20SKH
UM1-9F2HRSL-DS	MMD1S22-9SKH	UM1-11M2HRSL-DS	MMD1P22-11SKH	UM1-20F2HRSL-DS	MMD1S22-20SKH
UM1-9F2K	MMS22-9SK	UM1-11M2K	MMP22-11SK	UM1-20F2K	MMS22-20SK
UM1-9F2K-DS	MMD1S22-9SK	UM1-11M2K-DS	MMD1P22-11SK	UM1-20F2K-DS	MMD1S22-20SK
UM1-9F2KL	MMS22-9SK030	UM1-11M2KL	MMP22-11SK030	UM1-20F2KL	MMS22-20SK030
UM1-9F2KL-DS	MMD1S22-9SK030	UM1-11M2KL-DS	MMD1P22-11SK030	UM1-20F2KL-DS	MMD1S22-20SK030
UM1-9F2SL	MMS22-9SL	UM1-11M2SL	MMP22-11SL	UM1-20F2SL	MMS22-20SL
UM1-9F2SL-DS	MMD1S22-9SL	UM1-11M2SL-DS	MMD1P22-11SL	UM1-20F2SL-DS	MMD1S22-20SL
UM1-9M	MMP22-9026	UM1-14F	MMS22-14026	UM1-20M	MMP22-20026
UM1-9M-DS	MMD1P22-9026	UM1-14F-DS	MMD1S22-14026	UM1-20M-DS	MMD1P22-20026
UM1-9MHR	MMP22-9026H	UM1-14FHR	MMS22-14026H	UM1-20MHR	MMP22-20026H
UM1-9MHR-DS	MMD1P22-9026H	UM1-14FHR-DS	MMD1S22-14026H	UM1-20MHR-DS	MMD1P22-20026H
UM1-9M1HRSL	MMP22-9SK2H	UM1-14F1HRSL	MMS22-14SK2H	UM1-20M1HRSL	MMP22-20SK2H
UM1-9M1HRSL-DS	MMD1P22-9SK2H	UM1-14F1HRSL-DS	MMD1S22-14SK2H	UM1-20M1HRSL-DS	MMD1P22-20SK2H
UM1-9M1K	MMP22-9SK2	UM1-14F1K	MMS22-14SK2	UM1-20M1K	MMP22-20SK2
UM1-9M1K-DS	MMD1P22-9SK2	UM1-14F1K-DS	MMD1S22-14SK2	UM1-20M1K-DS	MMD1P22-20SK2
UM1-9M1KL	MMP22-9SK2030	UM1-14F1KL	MMS22-14SK2030	UM1-20M1KL	MMP22-20SK2030
UM1-9M1KL-DS	MMD1P22-9SK2030	UM1-14F1KL-DS	MMD1S22-14SK2030	UM1-20M1KL-DS	MMD1P22-20SK2030
UM1-9M1SL	MMP22-9SL2	UM1-14F1SL	MMS22-14SL2	UM1-20M1SL	MMP22-20SL2
UM1-9M1SL-DS	MMD1P22-9SL2	UM1-14F1SL-DS	MMD1S22-14SL2	UM1-20M1SL-DS	MMD1P22-20SL2
UM1-9M2HRSL	MMP22-9SKH	UM1-14F2HRSL	MMS22-14SKH	UM1-20M2HRSL	MMP22-20SKH
UM1-9M2HRSL-DS	MMD1P22-9SKH	UM1-14F2HRSL-DS	MMD1S22-14SKH	UM1-20M2HRSL-DS	MMD1P22-20SKH
UM1-9M2K	MMP22-9SK	UM1-14F2K	MMS22-14SK	UM1-20M2K	MMP22-20SK
UM1-9M2K-DS	MMD1P22-9SK	UM1-14F2K-DS	MMD1S22-14SK	UM1-20M2K-DS	MMD1P22-20SK
UM1-9M2KL	MMP22-9SK030	UM1-14F2KL	MMS22-14SK030	UM1-20M2KL	MMP22-20SK030
UM1-9M2KL-DS	MMD1P22-9SK030	UM1-14F2KL-DS	MMD1S22-14SK030	UM1-20M2KL-DS	MMD1P22-20SK030
UM1-9M2SL	MMP22-9SL	UM1-14F2SL	MMS22-14SL	UM1-20M2SL	MMP22-20SL
UM1-9M2SL-DS	MMD1P22-9SL	UM1-14F2SL-DS	MMD1S22-14SL	UM1-20M2SL-DS	MMD1P22-20SL
UM1-11F	MMS22-11026	UM1-14M	MMP22-14026	UM1-26F	MMS22-26026
UM1-11F-DS	MMD1S22-11026	UM1-14M-DS	MMD1P22-14026	UM1-26F-DS	MMD1S22-26026
UM1-11FHR	MMS22-11026H	UM1-14MHR	MMP22-14026H	UM1-26FHR	MMS22-26026H
UM1-11FHR-DS	MMD1S22-11026H	UM1-14MHR-DS	MMD1P22-14026H	UM1-26FHR-DS	MMD1S22-26026H
UM1-11F1HRSL	MMS22-11SK2H	UM1-14M1HRSL	MMP22-14SK2H	UM1-26F1HRSL	MMS22-26SK2H
UM1-11F1HRSL-DS	MMD1S22-11SK2H	UM1-14M1HRSL-DS	MMD1P22-14SK2H	UM1-26F1HRSL-DS	MMD1S22-26SK2H
UM1-11F1K	MMS22-11SK2	UM1-14M1K	MMP22-14SK2	UM1-26F1K	MMS22-26SK2
UM1-11F1K-DS	MMD1S22-11SK2	UM1-14M1K-DS	MMD1P22-14SK2	UM1-26F1K-DS	MMD1S22-26SK2
UM1-11F1KL	MMS22-11SK2030	UM1-14M1KL	MMP22-14SK2030	UM1-26F1KL	MMS22-26SK2030
UM1-11F1KL-DS	MMD1S22-11SK2030	UM1-14M1KL-DS	MMD1P22-14SK2030	UM1-26F1KL-DS	MMD1S22-26SK2030
UM1-11F1SL	MMS22-11SL2	UM1-14M1SL	MMP22-14SL2	UM1-26F1SL	MMS22-26SL2
UM1-11F1SL-DS	MMD1S22-11SL2	UM1-14M1SL-DS	MMD1P22-14SL2	UM1-26F1SL-DS	MMD1S22-26SL2
UM1-11F2HRSL	MMS22-11SKH	UM1-14M2HRSL	MMP22-14SKH	UM1-26F2HRSL	MMS22-26SKH
UM1-11F2HRSL-DS	MMD1S22-11SKH	UM1-14M2HRSL-DS	MMD1P22-14SKH	UM1-26F2HRSL-DS	MMD1S22-26SKH
UM1-11F2K	MMS22-11SK	UM1-14M2K	MMP22-14SK	UM1-26F2K	MMS22-26SK
UM1-11F2K-DS	MMD1S22-11SK	UM1-14M2K-DS	MMD1P22-14SK	UM1-26F2K-DS	MMD1S22-26SK
UM1-11F2KL	MMS22-11SK030	UM1-14M2KL	MMP22-14SK030	UM1-26F2KL	MMS22-26SK030
UM1-11F2KL-DS	MMD1S22-11SK030	UM1-14M2KL-DS	MMD1P22-14SK030	UM1-26F2KL-DS	MMD1S22-26SK030
UM1-11F2SL	MMS22-11SL	UM1-14M2SL	MMP22-14SL	UM1-26F2SL	MMS22-26SL
UM1-11F2SL-DS	MMD1S22-11SL	UM1-14M2SL-DS	MMD1P22-14SL	UM1-26F2SL-DS	MMD1S22-26SL
UM1-11M	MMP22-11026	UM1-20F	MMS22-20026	UM1-26M	MMP22-26026
UM1-11M-DS	MMD1P22-11026	UM1-20F-DS	MMD1S22-20026	UM1-26M-DS	MMD1P22-26026
UM1-11MHR	MMP22-11026H	UM1-20FHR	MMS22-20026H	UM1-26MHR	MMP22-26026H
UM1-11MHR-DS	MMD1P22-11026H	UM1-20FHR-DS	MMD1S22-20026H	UM1-26MHR-DS	MMD1P22-26026H
UM1-11M1HRSL	MMP22-11SK2H	UM1-20F1HRSL	MMS22-20SK2H	UM1-26M1HRSL	MMP22-26SK2H
UM1-11M1HRSL-DS	MMD1P22-11SK2H	UM1-20F1HRSL-DS	MMD1S22-20SK2H	UM1-26M1HRSL-DS	MMD1P22-26SK2H
UM1-11M1K	MMP22-11SK2	UM1-20F1K	MMS22-20SK2	UM1-26M1K	MMP22-26SK2
UM1-11M1K-DS	MMD1P22-11SK2	UM1-20F1K-DS	MMD1S22-20SK2	UM1-26M1K-DS	MMD1P22-26SK2





# Cross Reference - U.S. Components

U.S. Components/Vishay Dale Rack and Panel  
Connectors - Microminiature, Subminiature, Miniature

Vishay Dale

U.S. COMPONENTS	VISHAY DALE	U.S. COMPONENTS	VISHAY DALE	U.S. COMPONENTS	VISHAY DALE
SSM1-34M1KL	MMP24-34SK2030	SSM1-50F1KL	MMS24-50SK2030	UM1-5M1KL	MMP22-5SK2030
SSM1-34M1KL-DS	MMD1P24-34SK2030	SSM1-50F1KL-DS	MMD1S24-50SK2030	UM1-5M1KL-DS	MMD1P22-5SK2030
SSM1-34M1SL	MMP24-34SL2	SSM1-50F1SL	MMS24-50SL2	UM1-5M1SL	MMP22-5SL2
SSM1-34M1SL-DS	MMD1P24-34SL2	SSM1-50F1SL-DS	MMD1S24-50SL2	UM1-5M1SL-DS	MMD1P22-5SL2
SSM1-34M2HRSL	MMP24-34SKH	SSM1-50F2HRSL	MMS24-50SKH	UM1-5M2HRSL	MMP22-5SKH
SSM1-34M2HRSL-DS	MMD1P24-34SKH	SSM1-50F2HRSL-DS	MMD1S24-50SKH	UM1-5M2HRSL-DS	MMD1P22-5SKH
SSM1-34M2K	MMP24-34SK	SSM1-50F2K	MMS24-50SK	UM1-5M2K	MMP22-5SK
SSM1-34M2K-DS	MMD1P24-34SK	SSM1-50F2K-DS	MMD1S24-50SK	UM1-5M2K-DS	MMD1P22-5SK
SSM1-34M2KL	MMP24-34SK030	SSM1-50F2KL	MMS24-50SK030	UM1-5M2KL	MMP22-5SK030
SSM1-34M2KL-DS	MMD1P24-34SK030	SSM1-50F2KL-DS	MMD1S24-50SK030	UM1-5M2KL-DS	MMD1P22-5SK030
SSM1-34M2SL	MMP24-34SL	SSM1-50F2SL	MMS24-50SL	UM1-5M2SL	MMP22-5SL
SSM1-34M2SL-DS	MMD1P24-34SL	SSM1-50F2SL-DS	MMD1S24-50SL	UM1-5M2SL-DS	MMD1P22-5SL
SSM1-44F	MMS24-44026	SSM1-50M	MMP24-50026	UM1-7F	MMS22-7026
SSM1-44F-DS	MMD1S24-44026	SSM1-50M-DS	MMD1P24-50026	UM1-7F-DS	MMD1S22-7026
SSM1-44FHR	MMS24-44026H	SSM1-50MHR	MMP24-50026H	UM1-7FHR	MMS22-7026H
SSM1-44FHR-DS	MMD1S24-44026H	SSM1-50MHR-DS	MMD1P24-50026H	UM1-7FHR-DS	MMD1S22-7026H
SSM1-44F1HRSL	MMS24-44SK2H	SSM1-50M1HRSL	MMP24-50SK2H	UM1-7F1HRSL	MMS22-7SK2H
SSM1-44F1HRSL-DS	MMD1S24-44SK2H	SSM1-50M1HRSL-DS	MMD1P24-50SK2H	UM1-7F1HRSL-DS	MMD1S22-7SK2H
SSM1-44F1K	MMS24-44SK2	SSM1-50M1K	MMP24-50SK2	UM1-7F1K	MMS22-7SK2
SSM1-44F1K-DS	MMD1S24-44SK2	SSM1-50M1K-DS	MMD1P24-50SK2	UM1-7F1K-DS	MMD1S22-7SK2
SSM1-44F1KL	MMS24-44SK2030	SSM1-50M1KL	MMP24-50SK2030	UM1-7F1KL	MMS22-7SK2030
SSM1-44F1KL-DS	MMD1S24-44SK2030	SSM1-50M1KL-DS	MMD1P24-50SK2030	UM1-7F1KL-DS	MMD1S22-7SK2030
SSM1-44F1SL	MMS24-44SL2	SSM1-50M1SL	MMP24-50SL2	UM1-7F1SL	MMS22-7SL2
SSM1-44F1SL-DS	MMD1P24-44SL2	SSM1-50M1SL-DS	MMD1P24-50SL2	UM1-7F1SL-DS	MMD1S22-7SL2
SSM1-44F2HRSL	MMS24-44SKH	SSM1-50M2HRSL	MMP24-50SKH	UM1-7F2HRSL	MMS22-7SKH
SSM1-44F2HRSL-DS	MMD1S24-44SKH	SSM1-50M2HRSL-DS	MMD1P24-50SKH	UM1-7F2HRSL-DS	MMD1S22-7SKH
SSM1-44F2K	MMS24-44SK	SSM1-50M2K	MMP24-50SK	UM1-7F2K	MMS22-7SK
SSM1-44F2K-DS	MMD1S24-44SK	SSM1-50M2K-DS	MMD1P24-50SK	UM1-7F2K-DS	MMD1S22-7SK
SSM1-44F2KL	MMS24-44SK030	SSM1-50M2KL	MMP24-50SK030	UM1-7F2KL	MMS22-7SK030
SSM1-44F2KL-DS	MMD1P24-44SK030	SSM1-50M2KL-DS	MMD1P24-50SK030	UM1-7F2KL-DS	MMD1S22-7SK030
SSM1-44F2SL	MMS24-44SL	SSM1-50M2SL	MMP24-50SL	UM1-7F2SL	MMS22-7SL
SSM1-44F2SL-DS	MMD1P24-44SL	SSM1-50M2SL-DS	MMD1P24-50SL	UM1-7F2SL-DS	MMD1S22-7SL
SSM1-44M	MMP24-44026	UM1-5F	MMS22-5026	UM1-7M	MMP22-7026
SSM1-44M-DS	MMD1P24-44026	UM1-5F-DS	MMD1S22-5026	UM1-7M-DS	MMD1P22-7026
SSM1-44MHR	MMP24-44026H	UM1-5FHR	MMS22-5026H	UM1-7MHR	MMP22-7026H
SSM1-44MHR-DS	MMD1P24-44026H	UM1-5FHR-DS	MMD1S22-5026H	UM1-7MHR-DS	MMD1P22-7026H
SSM1-44M1HRSL	MMP24-44SK2H	UM1-5F1HRSL	MMS22-5SK2H	UM1-7M1HRSL	MMP22-7SK2H
SSM1-44M1HRSL-DS	MMD1P24-44SK2H	UM1-5F1HRSL-DS	MMD1S22-5SK2H	UM1-7M1HRSL-DS	MMD1P22-7SK2H
SSM1-44M1K	MMP24-44SK2	UM1-5F1K	MMS22-5SK2	UM1-7M1K	MMP22-7SK2
SSM1-44M1K-DS	MMD1P24-44SK2	UM1-5F1K-DS	MMD1S22-5SK2	UM1-7M1K-DS	MMD1P22-7SK2
SSM1-44M1KL	MMP24-44SK2030	UM1-5F1KL	MMS22-5SK2030	UM1-7M1KL	MMP22-7SK2030
SSM1-44M1KL-DS	MMD1P24-44SK2030	UM1-5F1KL-DS	MMD1S22-5SK2030	UM1-7M1KL-DS	MMD1P22-7SK2030
SSM1-44M1SL	MMP24-44SL2	UM1-5F1SL	MMS22-5SL2	UM1-7M1SL	MMP22-7SL2
SSM1-44M1SL-DS	MMD1P24-44SL2	UM1-5F1SL-DS	MMD1S22-5SL2	UM1-7M1SL-DS	MMD1P22-7SL2
SSM1-44M2HRSL	MMP24-44SKH	UM1-5F2HRSL	MMS22-5SKH	UM1-7M2HRSL	MMP22-7SKH
SSM1-44M2HRSL-DS	MMD1P24-44SKH	UM1-5F2HRSL-DS	MMD1S22-5SKH	UM1-7M2HRSL-DS	MMD1P22-7SKH
SSM1-44M2K	MMP24-44SK	UM1-5F2K	MMS22-5SK	UM1-7M2K	MMP22-7SK
SSM1-44M2K-DS	MMD1P24-44SK	UM1-5F2K-DS	MMD1S22-5SK	UM1-7M2K-DS	MMD1P22-7SK
SSM1-44M2KL	MMP24-44SK030	UM1-5F2KL	MMS22-5SK030	UM1-7M2KL	MMP22-7SK030
SSM1-44M2KL-DS	MMD1P24-44SK030	UM1-5F2KL-DS	MMD1S22-5SK030	UM1-7M2KL-DS	MMD1P22-7SK030
SSM1-44M2SL	MMP24-44SL	UM1-5F2SL	MMS22-5SL	UM1-7M2SL	MMP22-7SL
SSM1-44M2SL-DS	MMD1P24-44SL	UM1-5F2SL-DS	MMD1S22-5SL	UM1-7M2SL-DS	MMD1P22-7SL
SSM1-50F	MMS24-50026	UM1-5M	MMP22-5026	UM1-9F	MMS22-9026
SSM1-50F-DS	MMD1S24-50026	UM1-5M-DS	MMD1P22-5026	UM1-9F-DS	MMD1S22-9026
SSM1-50FHR	MMS24-50026H	UM1-5MHR	MMP22-5026H	UM1-9FHR	MMS22-9026H
SSM1-50FHR-DS	MMD1S24-50026H	UM1-5MHR-DS	MMD1P22-5026H	UM1-9FHR-DS	MMD1S22-9026H
SSM1-50F1HRSL	MMS24-50SK2H	UM1-5M1HRSL	MMP22-5SK2H	UM1-9F1HRSL	MMS22-9SK2H
SSM1-50F1HRSL-DS	MMD1S24-50SK2H	UM1-5M1HRSL-DS	MMD1P22-5SK2H	UM1-9F1HRSL-DS	MMD1S22-9SK2H
SSM1-50F1K	MMS24-50SK2	UM1-5M1K	MMP22-5SK2	UM1-9F1K	MMS22-9SK2
SSM1-50F1K-DS	MMD1S24-50SK2	UM1-5M1K-DS	MMD1P22-5SK2	UM1-9F1K-DS	MMD1S22-9SK2

# Cross Reference - U.S. Components



Vishay Dale

U.S. Components/Vishay Dale Rack and Panel  
Connectors - Microminiature, Subminiature, Miniature

U.S. COMPONENTS	VISHAY DALE	U.S. COMPONENTS	VISHAY DALE	U.S. COMPONENTS	VISHAY DALE
SSM1-14F1KL	MMS24-14SK2030	SSM1-20M1KL	MMP24-20SK2030	SSM1-29F1KL	MMS24-29SK2030
SSM1-14F1KL-DS	MMD1S24-14SK2030	SSM1-20M1KL-DS	MMD1P24-20SK2030	SSM1-29F1KL-DS	MMD1S24-29SK2030
SSM1-14F1SL	MMS24-14SL2	SSM1-20M1SL	MMP24-20SL2	SSM1-29F1SL	MMS24-29SL2
SSM1-14F1SL-DS	MMD1S24-14SL2	SSM1-20M1SL-DS	MMD1P24-20SL2	SSM1-29F1SL-DS	MMD1S24-29SL2
SSM1-14F2HRSL	MMS24-14SKH	SSM1-20M2HRSL	MMP24-20SKH	SSM1-29F2HRSL	MMS24-29SKH
SSM1-14F2HRSL-DS	MMD24-14SKH	SSM1-20M2HRSL-DS	MMD1P24-20SKH	SSM1-29F2HRSL-DS	MMD1S24-29SKH
SSM1-14F2K	MMS24-14SK	SSM1-20M2K	MMP24-20SK	SSM1-29F2K	MMS24-29SK
SSM1-14F2K-DS	MMD1S24-14SK	SSM1-20M2K-DS	MMD1P24-20SK	SSM1-29F2K-DS	MMD1S24-29SK
SSM1-14F2KL	MMS24-14SK030	SSM1-20M2KL	MMP24-20SK030	SSM1-29F2KL	MMS24-29SK030
SSM1-14F2KL-DS	MMD1S24-14SK030	SSM1-20M2KL-DS	MMD1P24-20SK030	SSM1-29F2KL-DS	MMD1S24-29SK030
SSM1-14F2SL	MMS24-14SL	SSM1-20M2SL	MMP24-20SL	SSM1-29F2SL	MMS24-29SL
SSM1-14F2SL-DS	MMD1S24-14SL	SSM1-20M2SL-DS	MMD1P24-20SL	SSM1-29F2SL-DS	MMD1S24-29SL
SSM1-14M	MMP24-14026	SSM1-26F	MMS24-26026	SSM1-29M	MMP24-29026
SSM1-14M-DS	MMD1P24-14026	SSM1-26F-DS	MMD1S24-26026	SSM1-29M-DS	MMD1P24-29026
SSM1-14MHR	MMP24-14026H	SSM1-26FHR	MMS24-26026H	SSM1-29MHR	MMP24-29026H
SSM1-14MHR-DS	MMD1P24-14026H	SSM1-26FHR-DS	MMD1S24-26026H	SSM1-29MHR-DS	MMD1P24-29026H
SSM1-14M1HRSL	MMP24-14SK2H	SSM1-26F1HRSL	MMS24-26SK2	SSM1-29M1HRSL	MMP24-29SK2H
SSM1-14M1HRSL-DS	MMD1P24-14SK2H	SSM1-26F1HRSL-DS	MMD1S24-26SK2H	SSM1-29M1HRSL-DS	MMD1P24-29SK2H
SSM1-14M1K	MMP24-14SK2	SSM1-26F1K	MMS24-26SK2	SSM1-29M1K	MMP24-29SK2
SSM1-14M1K-DS	MMD1P24-14SK2	SSM1-26F1K-DS	MMD1S24-26SK2	SSM1-29M1K-DS	MMD1P24-29SK2
SSM1-14M1KL	MMP24-14SK2030	SSM1-26F1KL	MMS24-26SK2030	SSM1-29M1KL	MMP24-29SK2030
SSM1-14M1KL-DS	MMD1P24-14SK2030	SSM1-26F1KL-DS	MMD1S24-26SK2030	SSM1-29M1KL-DS	MMD1P24-29SK2030
SSM1-14M1SL	MMP24-14SL2	SSM1-26F1SL	MMS24-26SL2	SSM1-29M1SL	MMP24-29SL2
SSM1-14M1SL-DS	MMD1P24-14SL2	SSM1-26F1SL-DS	MMD1S24-26SL2	SSM1-29M1SL-DS	MMD1P24-29SL2
SSM1-14M2HRSL	MMP24-14SKH	SSM1-26F2HRSL	MMS24-26SKH	SSM1-29M2HRSL	MMP24-29SKH
SSM1-14M2HRSL-DS	MMD1P24-14SKH	SSM1-26F2HRSL-DS	MMD1S24-26SKH	SSM1-29M2HRSL-DS	MMD1P24-29SKH
SSM1-14M2K	MMP24-14SK	SSM1-26F2K	MMS24-26SK	SSM1-29M2K	MMP24-29SK
SSM1-14M2K-DS	MMD1P24-14SK	SSM1-26F2K-DS	MMD1S24-26SK	SSM1-29M2K-DS	MMD1P24-29SK
SSM1-14M2KL	MMP24-14SK030	SSM1-26F2KL	MMS24-26SK030	SSM1-29M2KL	MMP24-29SK030
SSM1-14M2KL-DS	MMD1P24-14SK030	SSM1-26F2KL-DS	MMD1S24-26SK030	SSM1-29M2KL-DS	MMD1P24-29SK030
SSM1-14M2SL	MMP24-14SL	SSM1-26F2SL	MMS24-26SL	SSM1-29M2SL	MMP24-29SL
SSM1-14M2SL-DS	MMD1P24-14SL	SSM1-26F2SL-DS	MMD1S24-26SL	SSM1-29M2SL-DS	MMD1P24-29SL
SSM1-20F	MMS24-20026	SSM1-26M	MMP24-26026	SSM1-34F	MMS24-34026
SSM1-20F-DS	MMD1S24-20026	SSM1-26M-DS	MMD1P24-26026	SSM1-34F-DS	MMD1S24-34026
SSM1-20FHR	MMS24-20026H	SSM1-26MHR	MMP24-26026H	SSM1-34FHR	MMS24-34026H
SSM1-20FHR-DS	MMD1S24-20026H	SSM1-26MHR-DS	MMD1P24-26026H	SSM1-34FHR-DS	MMD1S24-34026H
SSM1-20F1HRSL	MMS24-20SK2H	SSM1-26M1HRSL	MMP24-26SK2H	SSM1-34F1HRSL	MMS24-34SK2H
SSM1-20F1HRSL-DS	MMD1S24-20SK2H	SSM1-26M1HRSL-DS	MMD1P24-26SK2H	SSM1-34F1HRSL-DS	MMD1S24-34SK2H
SSM1-20F1K	MMS24-20SK2	SSM1-26M1K	MMP24-26SK2	SSM1-34F1K	MMS24-34SK2
SSM1-20F1K-DS	MMD1S24-20SK2	SSM1-26M1K-DS	MMD1P24-26SK2	SSM1-34F1K-DS	MMD1S24-34SK2
SSM1-20F1KL	MMS24-20SK2030	SSM1-26M1KL	MMP24-26SK2030	SSM1-34F1KL	MMS24-34SK2030
SSM1-20F1KL-DS	MMD1S24-20SK2030	SSM1-26M1KL-DS	MMD1P24-26SK2030	SSM1-34F1KL-DS	MMD1S24-34SK2030
SSM1-20F1SL	MMS24-20SL2	SSM1-26M1SL	MMP24-26SL2	SSM1-34F1SL	MMS24-34SL2
SSM1-20F1SL-DS	MMD1S24-20SL2	SSM1-26M1SL-DS	MMD1P24-26SL2	SSM1-34F1SL-DS	MMD1S24-34SL2
SSM1-20F2HRSL	MMS24-20SKH	SSM1-26M2HRSL	MMP24-26SKH	SSM1-34F2HRSL	MMS24-34SKH
SSM1-20F2HRSL-DS	MMD1S24-20SKH	SSM1-26M2HRSL-DS	MMD1P24-26SKH	SSM1-34F2HRSL-DS	MMD1S24-34SKH
SSM1-20F2K	MMS24-20SK	SSM1-26M2K	MMP24-26SK	SSM1-34F2K	MMS24-34SK
SSM1-20F2K-DS	MMD1S24-20SK	SSM1-26M2K-DS	MMD1P24-26SK	SSM1-34F2K-DS	MMD1S24-34SK
SSM1-20F2KL	MMS24-20SK030	SSM1-26M2KL	MMP24-26SK030	SSM1-34F2KL	MMS24-34SK030
SSM1-20F2KL-DS	MMD1S24-20SK030	SSM1-26M2KL-DS	MMD1P24-26SK030	SSM1-34F2KL-DS	MMD1S24-34SK030
SSM1-20F2SL	MMS24-20SL	SSM1-26M2SL	MMP24-26SL	SSM1-34F2SL	MMS24-34SL
SSM1-20F2SL-DS	MMD1S24-20SL	SSM1-26M2SL-DS	MMD1P24-26SL	SSM1-34F2SL-DS	MMD1S24-34SL
SSM1-20M	MMP24-20026	SSM1-29F	MMS24-29026	SSM1-34M	MMP24-34026
SSM1-20M-DS	MMD1P24-20026	SSM1-29F-DS	MMD1S24-29026	SSM1-34M-DS	MMD1P24-34026
SSM1-20MHR	MMP24-20026H	SSM1-29FHR	MMS24-29026H	SSM1-34MHR	MMP24-34026H
SSM1-20MHR-DS	MMD1P24-20026H	SSM1-29FHR-DS	MMD1S24-29026H	SSM1-34MHR-DS	MMD1P24-34026H
SSM1-20M1HRSL	MMP24-20SK2H	SSM1-29F1HRSL	MMS24-29SK2H	SSM1-34M1HRSL	MMP24-34SK2H
SSM1-20M1HRSL-DS	MMD1P24-20SK2H	SSM1-29F1HRSL-DS	MMD1S24-29SK2H	SSM1-34M1HRSL-DS	MMD1P24-34SK2H
SSM1-20M1K	MMP24-20SK2	SSM1-29F1K	MMS24-29SK2	SSM1-34M1K	MMP24-34SK2
SSM1-20M1K-DS	MMD1P24-20SK2	SSM1-29F1K-DS	MMD1S24-29SK2	SSM1-34M1K-DS	MMD1P24-34SK2



# Cross Reference - U.S. Components

U.S. Components/Vishay Dale Rack and Panel  
Connectors - Microminiature, Subminiature, Miniature

Vishay Dale

U.S. COMPONENTS	VISHAY DALE	U.S. COMPONENTS	VISHAY DALE	U.S. COMPONENTS	VISHAY DALE
SM1-75F2SL	SMS20G-75SL3	SSM1-7F1KL	MMS24-7SK2030	SSM1-9M1KL	MMP24-9SK2030
SM1-75M	SMP20G-75027	SSM1-7F1KL-DS	MMD1S24-7SK2030	SSM1-9M1KL-DS	MMD1P24-9SK2030
SM1-75MHR	SMP20G-75027H	SSM1-7F1SL	MMS24-7SL2	SSM1-9M1SL	MMP24-9SL2
SM1-75MHS	SMP20G-75027H1	SSM1-7F1SL-DS	MMD1S24-7SL2	SSM1-9M1SL-DS	MMD1P24-9SL2
SM1-75M1HRSL	SMP20G-75SKH	SSM1-7F2HRSL	MMS24-7SKH	SSM1-9M2HRSL	MMP24-9SKH
SM1-75M1HSSL	SMP20G-75SKH1	SSM1-7F2HRSL-DS	MMD1S24-7SKH	SSM1-9M2HRSL-DS	MMD1P24-9SKH
SM1-75M1K	SMP20G-75SK	SSM1-7F2K	MMS24-7SK	SSM1-9M2K	MMP24-9SK
SM1-75M1SL	SMP20G-75SL	SSM1-7F2K-DS	MMD1S24-7SK	SSM1-9M2K-DS	MMD1P24-9SK
SM1-75M2HRSL	SMP20G-75SK3H	SSM1-7F2KL	MMS24-7SK030	SSM1-9M2KL	MMP24-9SK030
SM1-75M2HSSL	SMP20G-75SK3H1	SSM1-7F2KL-DS	MMD1S24-7SK030	SSM1-9M2KL-DS	MMD1P24-9SK030
SM1-75M2K	SMP20G-75SK3	SSM1-7F2SL	MMS24-7SL	SSM1-9M2SL	MMP24-9SL
SM1-75M2SL	SMP20G-75SL3	SSM1-7F2SL-DS	MMD1S24-7SL	SSM1-9M2SL-DS	MMD1P24-9SL
SSM1-5F	MMS24-5026	SSM1-7M	MMP24-7026	SSM1-11F	MMS24-11026
SSM1-5F-DS	MMD1S24-5026	SSM1-7M-DS	MMD1P24-7026	SSM1-11F-DS	MMD1S24-11026
SSM1-5FHR	MMS24-5026H	SSM1-7MHR	MMP24-7026H	SSM1-11FHR	MMS24-11026H
SSM1-5FHR-DS	MMD1S24-5026H	SSM1-7MHR-DS	MMD1P24-7026H	SSM1-11FHR-DS	MMD1S24-11026H
SSM1-5F1HRSL	MMS24-5SK2H	SSM1-7M1HRSL	MMP24-7SK2H	SSM1-11F1HRSL	MMS24-11SK2H
SSM1-5F1HRSL-DS	MMD1S24-5SK2H	SSM1-7M1HRSL-DS	MMD1P24-7SK2H	SSM1-11F1HRSL-DS	MMD1S24-11SK2H
SSM1-5F1K	MMS24-5SK2	SSM1-7M1K	MMP24-7SK2	SSM1-11F1K	MMS24-11SK2
SSM1-5F1K-DS	MMD1S24-5SK2	SSM1-7M1K-DS	MMD1P24-7SK2	SSM1-11F1K-DS	MMD1S24-11SK2
SSM1-5F1KL	MMS24-5SK2030	SSM1-7M1KL	MMP24-7SK2030	SSM1-11F1KL	MMS24-11SK2030
SSM1-5F1KL-DS	MMD1S24-5SK2030	SSM1-7M1KL-DS	MMD1P24-7SK2030	SSM1-11F1KL-DS	MMD1S24-11SK2030
SSM1-5F1SL	MMS24-5SL2	SSM1-7M1SL	MMP24-7SL2	SSM1-11F1SL	MMS24-11SL2
SSM1-5F1SL-DS	MMD1S24-5SL2	SSM1-7M1SL-DS	MMD1P24-7SL2	SSM1-11F1SL-DS	MMD1S24-11SL2
SSM1-5F2HRSL	MMS24-5SKH	SSM1-7M2HRSL	MMP24-7SKH	SSM1-11F2HRSL	MMS24-11SKH
SSM1-5F2HRSL-DS	MMD1S24-5SKH	SSM1-7M2HRSL-DS	MMD1P24-7SKH	SSM1-11F2HRSL-DS	MMD1S24-11SKH
SSM1-5F2K	MMS24-5SK	SSM1-7M2K	MMP24-7SK	SSM1-11F2K	MMS24-11SK
SSM1-5F2K-DS	MMD1S24-5SK	SSM1-7M2K-DS	MMD1P24-7SK	SSM1-11F2K-DS	MMD1S24-11SK
SSM1-5F2KL	MMS24-5SK030	SSM1-7M2KL	MMP24-7SK030	SSM1-11F2KL	MMS24-11SK030
SSM1-5F2KL-DS	MMD1S24-5SK030	SSM1-7M2KL-DS	MMD1P24-7SK030	SSM1-11F2KL-DS	MMD1S24-11SK030
SSM1-5F2SL	MMS24-5SL	SSM1-7M2SL	MMP24-7SL	SSM1-11F2SL	MMS24-11SL
SSM1-5F2SL-DS	MMD1S24-5SL	SSM1-7M2SL-DS	MMD1P24-7SL	SSM1-11F2SL-DS	MMD1S24-11SL
SSM1-5M	MMP24-5026	SSM1-9F	MMS24-9026	SSM1-11M	MMP24-11026
SSM1-5M-DS	MMD1P24-5026	SSM1-9F-DS	MMD1S24-9026	SSM1-11M-DS	MMD1P24-11026
SSM1-5MHR	MMP24-5026H	SSM1-9FHR	MMS24-9026H	SSM1-11MHR	MMP24-11026H
SSM1-5MHR-DS	MMD1P24-5026H	SSM1-9FHR-DS	MMD1S24-9026H	SSM1-11MHR-DS	MMD1P24-11026H
SSM1-5M1HRSL	MMP24-5SK2H	SSM1-9F1HRSL	MMS24-9SK2H	SSM1-11M1HRSL	MMP24-11SK2H
SSM1-5M1HRSL-DS	MMD1P24-5SK2H	SSM1-9F1HRSL-DS	MMD1S24-9SK2H	SSM1-11M1HRSL-DS	MMD1P24-11SK2H
SSM1-5M1K	MMP24-5SK2	SSM1-9F1K	MMS24-9SK2	SSM1-11M1K	MMP24-11SK2
SSM1-5M1K-DS	MMD1P24-5SK2	SSM1-9F1K-DS	MMD1S24-9SK2	SSM1-11M1K-DS	MMD1P24-11SK2
SSM1-5M1KL	MMP24-5SK2030	SSM1-9F1KL	MMS24-9SK2030	SSM1-11M1KL	MMP24-11SK2030
SSM1-5M1KL-DS	MMD1P24-5SK2030	SSM1-9F1KL-DS	MMD1S24-9SK2030	SSM1-11M1KL-DS	MMD1P24-11SK2030
SSM1-5M1SL	MMP24-5SL2	SSM1-9F1SL	MMS24-9SL2	SSM1-11M1SL	MMP24-11SL2
SSM1-5M1SL-DS	MMD1P24-5SL2	SSM1-9F1SL-DS	MMD1S24-9SL2	SSM1-11M1SL-DS	MMD1P24-11SL2
SSM1-5M2HRSL	MMP24-5SKH	SSM1-9F2HRSL	MMS24-9SKH	SSM1-11M2HRSL	MMP24-11SKH
SSM1-5M2HRSL-DS	MMD1P24-5SKH	SSM1-9F2HRSL-DS	MMD1S24-9SKH	SSM1-11M2HRSL-DS	MMD1P24-11SKH
SSM1-5M2K	MMP24-5SK	SSM1-9F2K	MMS24-9SK	SSM1-11M2K	MMP24-11SK
SSM1-5M2K-DS	MMD1P24-5SK	SSM1-9F2K-DS	MMD1S24-9SK	SSM1-11M2K-DS	MMD1P24-11SK
SSM1-5M2KL	MMP24-5SK030	SSM1-9F2KL	MMS24-9SK030	SSM1-11M2KL	MMP24-11SK030
SSM1-5M2KL-DS	MMD1P24-5SK030	SSM1-9F2KL-DS	MMD1S24-9SK030	SSM1-11M2KL-DS	MMD1P24-11SK030
SSM1-5M2SL	MMP24-5SL	SSM1-9F2SL	MMS24-9SL	SSM1-11M2SL	MMP24-11SL
SSM1-5M2SL-DS	MMD1P24-5SL	SSM1-9F2SL-DS	MMD1S24-9SL	SSM1-11M2SL-DS	MMD1P24-11SL
SSM1-7F	MMS24-7026	SSM1-9M	MMP24-9026	SSM1-14F	MMS24-14026
SSM1-7F-DS	MMD1S24-7026	SSM1-9M-DS	MMD1P24-9026	SSM1-14F-DS	MMD1S24-14026
SSM1-7FHR	MMS24-7026H	SSM1-9MHR	MMP24-9026H	SSM1-14FHR	MMS24-14026H
SSM1-7FHR-DS	MMD1S24-7026H	SSM1-9MHR-DS	MMD1P24-9026H	SSM1-14FHR-DS	MMD1S24-14026H
SSM1-7F1HRSL	MMS24-7SK2H	SSM1-9M1HRSL	MMP24-9SK2H	SSM1-14F1HRSL	MMS24-14SK2H
SSM1-7F1HRSL-DS	MMD1S24-7SK2H	SSM1-9M1HRSL-DS	MMD1P24-9SK2H	SSM1-14F1HRSL-DS	MMD1S24-14SK2H
SSM1-7F1K	MMS24-7SK2	SSM1-9M1K	MMP24-9SK2	SSM1-14F1K	MMS24-14SK2
SSM1-7F1K-DS	MMD1S24-7SK2	SSM1-9M1K-DS	MMD1P24-9SK2	SSM1-14F1K-DS	MMD1S24-14SK2

# Cross Reference - U.S. Components



Vishay Dale

U.S. Components/Vishay Dale Rack and Panel  
Connectors - Microminiature, Subminiature, Miniature

U.S. COMPONENTS	VISHAY DALE	U.S. COMPONENTS	VISHAY DALE	U.S. COMPONENTS	VISHAY DALE
SM1-7F1SL	SMS20G-7SL	SM1-20F	SMS20G-20027	SM1-34M1K	SMP20G-34SK
SM1-7F2HRSL	SMS20G-7SK3H	SM1-20FHR	SMS20G-20027H	SM1-34M1SL	SMP20G-34SL
SM1-7F2HSSL	SMS20G-7SK3H1	SM1-20FHS	SMS20G-20027H1	SM1-34M2HRSL	SMP20G-34SK3H
SM1-7F2K	SMS20G-7SK3	SM1-20F1HRSL	SMS20G-20SKH	SM1-34M2HSSL	SMP20G-34SK3H1
SM1-7F2SL	SMS20G-7SL3	SM1-20F1HSSL	SMS20G-20SKH1	SM1-34M2K	SMP20G-34SK3
SM1-7M	SMP20G-7027	SM1-20F1K	SMS20G-20SK	SM1-34M2SL	SMP20G-34SL3
SM1-7MHR	SMP20G-7027H	SM1-20F1SL	SMS20G-20SL	SM1-42F	SMS20G-42027
SM1-7MHS	SMP20G-7027H1	SM1-20F2HRSL	SMS20G-20SK3H	SM1-42FHR	SMS20G-42027H
SM1-7M1HRSL	SMP20G-7SKH	SM1-20F2HSSL	SMS20G-20SK3H1	SM1-42FHS	SMS20G-42027H1
SM1-7M1HSSL	SMP20G-7SKH1	SM1-20F2K	SMS20G-20SK3	SM1-42F1HRSL	SMS20G-42SKH
SM1-7M1K	SMP20G-7SK	SM1-20F2SL	SMS20G-20SL3	SM1-42F1HSSL	SMS20G-42SKH1
SM1-7M1SL	SMP20G-7SL	SM1-20M	SMP20G-20027	SM1-42F1K	SMS20G-42SK
SM1-7M2HRSL	SMP20G-7SK3H	SM1-20MHR	SMP20G-20027H	SM1-42F1SL	SMS20G-42SL
SM1-7M2HSSL	SMP20G-7SK3H1	SM1-20MHS	SMP20G-20027H1	SM1-42F2HRSL	SMS20G-42SK3H
SM1-7M2K	SMP20G-7SK3	SM1-20M1HRSL	SMP20G-20SKH	SM1-42F2HSSL	SMS20G-42SK3H1
SM1-7M2SL	SMP20G-7SL3	SM1-20M1HSSL	SMP20G-20SKH1	SM1-42F2K	SMS20G-42SK3
SM1-11F	SMS20G-11027	SM1-20M1K	SMP20G-20SK	SM1-42F2SL	SMS20G-42SL3
SM1-11FHR	SMS20G-11027H	SM1-20M1SL	SMS20G-20SL	SM1-42M	SMP20G-42027
SM1-11FHS	SMS20G-11027H1	SM1-20M2HRSL	SMP20G-20SK3H	SM1-42MHR	SMP20G-42027H
SM1-11F1HRSL	SMS20G-11SKH	SM1-20M2HSSL	SMP20G-20SK3H1	SM1-42MHS	SMP20G-42027H1
SM1-11F1HSSL	SMS20G-11SKH1	SM1-20M2K	SMP20G-20SK3	SM1-42M1HRSL	SMP20G-42SKH
SM1-11F1K	SMS20G-11SK	SM1-20M2SL	SMP20G-20SL3	SM1-42M1HSSL	SMP20G-42SKH1
SM1-11F1SL	SMS20G-11SL	SM1-26F	SMS20G-26027	SM1-42M1K	SMP20G-42SK
SM1-11F2HRSL	SMS20G-11SK3H	SM1-26FHR	SMS20G-26027H	SM1-42M1SL	SMP20G-42SL
SM1-11F2HSSL	SMS20G-11SK3H1	SM1-26FHS	SMS20G-26027H1	SM1-42M2HRSL	SMP20G-42SK3H
SM1-11F2K	SMS20G-11SK3	SM1-26F1HRSL	SMS20G-26SKH	SM1-42M2HSSL	SMP20G-42SK3H1
SM1-11F2SL	SMS20G-11SL3	SM1-26F1HSSL	SMS20G-26SKH1	SM1-42M2K	SMP20G-42SK3
SM1-11M	SMP20G-11027	SM1-26F1K	SMS20G-26SK	SM1-42M2SL	SMP20G-42SL3
SM1-11MHR	SMP20G-11027H	SM1-26F1SL	SMS20G-26SL	SM1-50F	SMS20G-50027
SM1-11MHS	SMP20G-11027H1	SM1-26F2HRSL	SMS20G-26SK3H	SM1-50FHR	SMS20G-50027H
SM1-11M1HRSL	SMP20G-11SKH	SM1-26F2HSSL	SMS20G-26SK3H1	SM1-50FHS	SMS20G-50027H1
SM1-11M1HSSL	SMP20G-11SKH1	SM1-26F2K	SMS20G-26SK3	SM1-50F1HRSL	SMS20G-50SKH
SM1-11M1K	SMP20G-11SK	SM1-26F2SL	SMS20G-26SL3	SM1-50F1HSSL	SMS20G-50SKH1
SM1-11M1SL	SMP20G-11SL	SM1-26M	SMP20G-26027	SM1-50F1K	SMS20G-50SK
SM1-11M2HRSL	SMP20G-11SK3H	SM1-26MHR	SMP20G-26027H	SM1-50F1SL	SMS20G-50SL
SM1-11M2HSSL	SMP20G-11SK3H1	SM1-26MHS	SMP20G-26027H1	SM1-50F2HRSL	SMS20G-50SK3H
SM1-11M2K	SMP20G-11SK3	SM1-26M1HRSL	SMP20G-26SKH	SM1-50F2HSSL	SMS20G-50SK3H1
SM1-11M2SL	SMP20G-11SL3	SM1-26M1HSSL	SMP20G-26SKH1	SM1-50F2K	SMS20G-50SK3
SM1-14F	SMS20G-14027	SM1-26M1K	SMP20G-26SK	SM1-50F2SL	SMS20G-50SL3
SM1-14FHR	SMS20G-14027H	SM1-26M1SL	SMP20G-26SL	SM1-50M	SMP20G-50027
SM1-14FHS	SMS20G-14027H1	SM1-26M2HRSL	SMP20G-26SK3H	SM1-50MHR	SMP20G-50027H
SM1-14F1HRSL	SMS20G-14SKH	SM1-26M2HSSL	SMP20G-26SK3H1	SM1-50MHS	SMP20G-50027H1
SM1-14F1HSSL	SMS20G-14SKH1	SM1-26M2K	SMP20G-26SK3	SM1-50M1HRSL	SMP20G-50SKH
SM1-14F1K	SMS20G-14SK	SM1-26M2SL	SMP20G-26SL3	SM1-50M1HSSL	SMP20G-50SKH1
SM1-14F1SL	SMS20G-14SL	SM1-34F	SMS20G-34027	SM1-50M1K	SMP20G-50SK
SM1-14F2HRSL	SMS20G-14SK3H	SM1-34FHR	SMS20G-34027H	SM1-50M1SL	SMP20G-50SL
SM1-14F2HSSL	SMS20G-14SK3H1	SM1-34FHS	SMS20G-34027H1	SM1-50M2HRSL	SMP20G-50SK3H
SM1-14F2K	SMS20G-14SK3	SM1-34F1HRSL	SMS20G-34SKH	SM1-50M2HSSL	SMP20G-50SK3H1
SM1-14F2SL	SMS20G-14SL3	SM1-34F1HSSL	SMS20G-34SKH1	SM1-50M2K	SMP20G-50SK3
SM1-14M	SMP20G-14027	SM1-34F1K	SMS20G-34SK	SM1-50M2SL	SMP20G-50SL3
SM1-14MHR	SMP20G-14027H	SM1-34F1SL	SMS20G-34SL	SM1-75F	SMS20G-75027
SM1-14MHS	SMP20G-14027H1	SM1-34F2HRSL	SMS20G-34SK3H	SM1-75FHR	SMS20G-75027H
SM1-14M1HRSL	SMP20G-14SKH	SM1-34F2HSSL	SMS20G-34SK3H1	SM1-75FHS	SMS20G-75027H1
SM1-14M1HSSL	SMP20G-14SKH1	SM1-34F2K	SMS20G-34SK3	SM1-75F1HRSL	SMS20G-75SKH
SM1-14M1K	SMP20G-14SK	SM1-34F2SL	SMS20G-34SL3	SM1-75F1HSSL	SMS20G-75SKH1
SM1-14M1SL	SMP20G-14SL	SM1-34M	SMP20G-34027	SM1-75F1K	SMS20G-75SK
SM1-14M2HRSL	SMP20G-14SK3H	SM1-34MHR	SMP20G-34027H	SM1-75F1SL	SMS20G-75SL
SM1-14M2HSSL	SMP20G-14SK3H1	SM1-34MHS	SMP20G-34027H1	SM1-75F2HRSL	SMS20G-75SK3H
SM1-14M2K	SMP20G-14SK3	SM1-34M1HRSL	SMP20G-34SKH	SM1-75F2HSSL	SMS20G-75SK3H1
SM1-14M2SL	SMP20G-14SL3	SM1-34M1HSSL	SMP20G-34SKH1	SM1-75F2K	SMS20G-75SK3



# Cross Reference - U.S. Components

U.S. Components/Vishay Dale Rack and Panel  
Connectors - Microminiature, Subminiature, Miniature

Vishay Dale

U.S. COMPONENTS	VISHAY DALE	U.S. COMPONENTS	VISHAY DALE	U.S. COMPONENTS	VISHAY DALE
CUM1-29F	CMMS22-29026	CUM1-50F	CMMS22-50026	M1-34F-SS-FS80	MS20-34
CUM1-29F-DS	CMMD1S22-29026	CUM1-50F-DS	CMMD1S22-50026	M1-34F-W-FS80	MS20-34W
CUM1-29FHR	CMS22-29026H	CUM1-50FHR	CMMS22-50026H	M1-34F1K-FS80	MS20-34SK
CUM1-29FHR-DS	CMMD1S22-29026H	CUM1-50FHR-DS	CMMD1S22-50026H	M1-34F1SL-FS80	MS20-34SL
CUM1-29F1HRSL	CMMS22-29SK2H	CUM1-50F1HRSL	CMMS22-50SK2H	M1-34M-SS-FS80	MP20-34
CUM1-29F1HRSL-DS	CMMD1S22-29SK2H	CUM1-50F1HRSL-DS	CMMD1S22-50SK2H	M1-34M-W-FS80	MP20-34W
CUM1-29F1K	CMMS22-29SK2	CUM1-50F1K	CMMS22-50SK2	M1-34M1K-FS80	MP20-34SK
CUM1-29F1K-DS	CMMD1S22-29SK2	CUM1-50F1K-DS	CMMD1S22-50SK2	M1-34M1SL-FS80	MP20-34SL
CUM1-29F1KL	CMMS22-29SK2030	CUM1-50F1KL	CMMS22-50SK2030	M1-41F-SS-FS80	MS20-41
CUM1-29F1KL-DS	CMMD1S22-29SK2030	CUM1-50F1KL-DS	CMMD1S22-50SK2030	M1-41F-W-FS80	MS20-41W
CUM1-29F1SL	CMMS22-29SL2	CUM1-50F1SL	CMMS22-50SL2	M1-41F1K-FS80	MS20-41SK
CUM1-29F1SL-DS	CMMD1S22-29SL2	CUM1-50F1SL-DS	CMMD1S22-50SL2	M1-41F1SL-FS80	MS20-41SL
CUM1-29F2HRSL	CMMS22-29SKH	CUM1-50F2HRSL	CMMS22-50SKH	M1-41M-SS-FS80	MP20-41
CUM1-29F2HRSL-DS	CMMD1S22-29SKH	CUM1-50F2HRSL-DS	CMMD1S22-50SKH	M1-41M-W-FS80	MP20-41W
CUM1-29F2K	CMMS22-29SK	CUM1-50F2K	CMMS22-50SK	M1-41M1K-FS80	MP20-41SK
CUM1-29F2K-DS	CMMD1S22-29SK	CUM1-50F2K-DS	CMMD1S22-50SK	M1-41M1SL-FS80	MP20-41SL
CUM1-29F2KL	CMMS22-29SK030	CUM1-50F2KL	CMMS22-50SK030	M1-50F-SS-FS80	MS20-50
CUM1-29F2KL-DS	CMMD1S22-29SK030	CUM1-50F2KL-DS	CMMD1S22-50SK030	M1-50F-W-FS80	MS20-50W
CUM1-29F2SL	CMMS22-29SL	CUM1-50F2SL	CMMS22-50SL	M1-50F1K-FS80	MS20-50SK
CUM1-29F2SL-DS	CMMD1S22-29SL	CUM1-50F2SL-DS	CMMD1S22-50SL	M1-50F1SL-FS80	MS20-50SL
CUM1-34F	CMMS22-34026	M1-7F-SS-FS80	MS20-7	M1-50M-SS-FS80	MP20-50
CUM1-34F-DS	CMMD1S22-34026	M1-7F-W-FS80	MS20-7W	M1-50M-W-FS80	MP20-50W
CUM1-34FHR	CMMS22-34026H	M1-7F1K-FS80	MS20-7SK	M1-50M1K-FS80	MP20-50SK
CUM1-34FHR-DS	CMMD1S22-34026H	M1-7F1SL-FS80	MS20-7SL	M1-50M1SL-FS80	MP20-50SL
CUM1-34F1HRSL	CMMS22-34SK2H	M1-7M-SS-FS80	MP20-7	M1-75F-SS-FS80	MS20-75
CUM1-34F1HRSL-DS	CMMD1S22-34SK2H	M1-7M-W-FS80	MP20-7W	M1-75F-W-FS80	MS20-75W
CUM1-34F1K	CMMS22-34SK2	M1-7M1K-FS80	MP20-7SK	M1-75F1K-FS80	MS20-75SK
CUM1-34F1K-DS	CMMD1S22-342K2	M1-7M1SL-FS80	MP20-7SL	M1-75F1SL-FS80	MS20-75SL
CUM1-34F1KL	CMMS22-34SK2030	M1-14F-SS-FS80	MS20-14	M1-75M-SS-FS80	MP20-75
CUM1-34F1KL-DS	CMMD1S22-34SK2030	M1-14F-W-FS80	MS20-14W	M1-75M-W-FS80	MP20-75W
CUM1-34F1SL	CMMS22-34SL2	M1-14F1K-FS80	MS20-14SK	M1-75M1K-FS80	MP20-75SK
CUM1-34F1SL-DS	CMMD1S22-34SL2	M1-14F1SL-FS80	MS20-14SL	M1-75M1SL-FS80	MP20-75SL
CUM1-34F2HRSL	CMMS22-34SKH	M1-14M-SS-FS80	MP20-14	SM1-5F	SMS20G-5027
CUM1-34F2HRSL-DS	CMMD1S22-34SKH	M1-14M-W-FS80	MP20-14W	SM1-5FHR	SMS20G-5027H
CUM1-34F2K	CMMS22-34SK	M1-14M1K-FS80	MP20-14SK	SM1-5FHS	SMS20G-5027H1
CUM1-34F2K-DS	CMMD1S22-34SK	M1-14M1SL-FS80	MP20-14SL	SM1-5F1HRSL	SMS20G-5SKH
CUM1-34F2KL	CMMS22-34SK030	M1-18F-SS-FS80	MS20-18	SM1-5F1HSSL	SMS20G-5SKH1
CUM1-34F2KL-DS	CMMD1S22-34SK030	M1-18F-W-FS80	MS20-18W	SM1-5F1K	SMS20G-5SK
CUM1-34F2SL	CMMS22-34SL	M1-18F1K-FS80	MS20-18SK	SM1-5F1SL	SMS20G-5SL
CUM1-34F2SL-DS	CMMD1S22-34SL	M1-18F1SL-FS80	MS20-18SL	SM1-5F2HRSL	SMS20G-5SK3H
CUM1-44F	CMMS22-44026	M1-18M-SS-FS80	MP20-18	SM1-5F2HSSL	SMS20G-5SK3H1
CUM1-44F-DS	CMMD1S22-44026	M1-18M-W-FS80	MP20-18W	SM1-5F2K	SMS20G-5SK3
CUM1-44FHR	CMMS22-44026H	M1-18M1K-FS80	MP20-18SK	SM1-5F2SL	SMS20G-5SL3
CUM1-44FHR-DS	CMMD1S22-44026H	M1-18M1SL-FS80	MP20-18SL	SM1-5M	SMP20G-5027
CUM1-44F1HRSL	CMMS22-44SK2H	M1-20F-SS-FS80	MS20-20	SM1-5MHR	SMP20G-5027H
CUM1-44F1HRSL-DS	CMMD1S22-44SK2H	M1-20F-W-FS80	MS20-20W	SM1-5MHS	SMP20G-5027H1
CUM1-44F1K	CMMS22-44SK2	M1-20F1K-FS80	MS20-20SK	SM1-5M1HRSL	SMP20G-5SKH
CUM1-44F1K-DS	CMMD1S22-44SK2	M1-20F1SL-FS80	MS20-20SL	SM1-5M1HSSL	SMP20G-5SKH1
CUM1-44F1KL	CMMS22-44SK2030	M1-20M-SS-FS80	MP20-20	SM1-5M1K	SMP20G-5SK
CUM1-44F1KL-DS	CMMD1S22-44SK2030	M1-20M-W-FS80	MP20-20W	SM1-5M1SL	SMP20G-5SL
CUM1-44F1SL	CMMS22-44SL2	M1-20M1K-FS80	MP20-20SK	SM1-5M2HRSL	SMP20G-5SK3H
CUM1-44F1SL-DS	CMMD1S22-44SL2	M1-20M1SL-FS80	MP20-20SL	SM1-5M2HSSL	SMP20G-5SK3H1
CUM1-44F2HRSL	CMMS22-44SKH	M1-26F-SS-FS80	MS20-26	SM1-5M2K	SMP20G-5SK3
CUM1-44F2HRSL-DS	CMMD1S22-44SKH	M1-26F-W-FS80	MS20-26W	SM1-5M2SL	SMP20G-5SL3
CUM1-44F2K	CMMS22-44SK	M1-26F1K-FS80	MS20-26SK	SM1-7F	SMS20G-7027
CUM1-44F2K-DS	CMMD1S22-44SK	M1-26F1SL-FS80	MS20-26SL	SM1-7FHR	SMS20G-7027H
CUM1-44F2KL	CMMS22-44SK030	M1-26M-SS-FS80	MP20-26	SM1-7FHS	SMS20G-7027H1
CUM1-44F2KL-DS	CMMD1S22-44SK030	M1-26M-W-FS80	MP20-26W	SM1-7F1HRSL	SMS20G-7SKH
CUM1-44F2SL	CMMS22-44SL	M1-26M1K-FS80	MP20-26SK	SM1-7F1HSSL	SMS20G-7SKH1
CUM1-44F2SL-DS	CMMD1S22-44SL	M1-26M1SL-FS80	MP20-26SL	SM1-7F1K	SMS20G-7SK



# Cross Reference - U.S. Components



Vishay Dale

U.S. Components/Vishay Dale Rack and Panel  
Connectors - Microminiature, Subminiature, Miniature

U.S. COMPONENTS	VISHAY DALE	U.S. COMPONENTS	VISHAY DALE	U.S. COMPONENTS	VISHAY DALE
CSSM1-44F	CMMS24-44026	CUM1-7F	CMMS22-7026	CUM1-14F	CMMS22-14026
CSSM1-44F-DS	CMMD1S24-44026	CUM1-7F-DS	CMMD1S22-7026	CUM1-14F-DS	CMMD1S22-14026
CSSM1-44FHR	CMMS24-44026H	CUM1-7FHR	CMMS22-7026H	CUM1-14FHR	CMMS22-14026H
CSSM1-44FHR-DS	CMMD1S24-44026H	CUM1-7FHR-DS	CMMD1S22-7026H	CUM1-14FHR-DS	CMMD1S22-14026H
CSSM1-44F1HRSL	CMMS24-44SK2H	CUM1-7F1HRSL	CMMS22-7SK2H	CUM1-14F1HRSL	CMMS22-14SK2H
CSSM1-44F1HRSL-DS	CMMD1S24-44SK2H	CUM1-7F1HRSL-DS	CMMD1S22-7SK2H	CUM1-14F1HRSL-DS	CMMD1S22-14SK2H
CSSM1-44F1K	CMMS24-44SK2	CUM1-7F1K	CMMS22-7SK2	CUM1-14F1K	CMMS22-14SK2
CSSM1-44F1K-DS	CMMD1S24-44SK2	CUM1-7F1K-DS	CMMD1S22-7SK2	CUM1-14F1K-DS	CMMD1S22-14SK2
CSSM1-44F1KL	CMMS24-44SK2030	CUM1-7F1KL	CMMS22-7SK2030	CUM1-14F1KL	CMMS22-14SK2030
CSSM1-44F1KL-DS	CMMD1S24-44SK2030	CUM1-7F1KL-DS	CMMD1S22-7SK2030	CUM1-14F1KL-DS	CMMD1S22-14SK2030
CSSM1-44F1SL	CMMS24-44SL2	CUM1-7F1SL	CMMS22-7SL2	CUM1-14F1SL	CMMS22-14SL2
CSSM1-44F1SL-DS	CMMD1S24-44SL2	CUM1-7F1SL-DS	CMMD1S22-7SL2	CUM1-14F1SL-DS	CMMD1S22-14SL2
CSSM1-44F2HRSL	CMMS24-44SKH	CUM1-7F2HRSL	CMMS22-7SKH	CUM1-14F2HRSL	CMMS22-14SKH
CSSM1-44F2HRSL-DS	CMMD1S24-44SKH	CUM1-7F2HRSL-DS	CMMD1S22-7SKH	CUM1-14F2HRSL-DS	CMMD1S22-14SKH
CSSM1-44F2K	CMMS24-44SK	CUM1-7F2K	CMMS22-7SK	CUM1-14F2K	CMMS22-14SK
CSSM1-44F2K-DS	CMMD1S24-44SK	CUM1-7F2K-DS	CMMD1S22-7SK	CUM1-14F2K-DS	CMMD1S22-14SK
CSSM1-44F2KL	CMMS24-44SK030	CUM1-7F2KL	CMMS22-7SK030	CUM1-14F2KL	CMMS22-14SK030
CSSM1-44F2KL-DS	CMMD1S24-44SK030	CUM1-7F2KL-DS	CMMD1S22-7SK030	CUM1-14F2KL-DS	CMMD1S22-14SK030
CSSM1-44F2SL	CMMS24-44SL	CUM1-7F2SL	CMMS22-7SL	CUM1-14F2SL	CMMS22-14SL
CSSM1-44F2SL-DS	CMMD1S24-44SL	CUM1-7F2SL-DS	CMMD1S22-7SL	CUM1-14F2SL-DS	CMMD1S22-14SL
CSSM1-50F	CMMS24-50026	CUM1-9F	CMMS22-9026	CUM1-20F	CMMS22-20026
CSSM1-50F-DS	CMMD1S24-50026	CUM1-9F-DS	CMMD1S22-9026	CUM1-20F-DS	CMMD1S22-20026
CSSM1-50FHR	CMMS24-50026H	CUM1-9FHR	CMMS22-9026H	CUM1-20FHR	CMMS22-20026H
CSSM1-50FHR-DS	CMMD1S24-50026H	CUM1-9FHR-DS	CMMD1S22-9026H	CUM1-20FHR-DS	CMMD1S22-20026H
CSSM1-50F1HRSL	CMMS24-50SK2H	CUM1-9F1HRSL	CMMS22-9SK2H	CUM1-20F1HRSL	CMMS22-20SK2H
CSSM1-50F1HRSL-DS	CMMD1S24-50SK2H	CUM1-9F1HRSL-DS	CMMD1S22-9SK2H	CUM1-20F1HRSL-DS	CMMD1S22-20SK2H
CSSM1-50F1K	CMMS24-50SK2	CUM1-9F1K	CMMS22-9SK2	CUM1-20F1K	CMMS22-20SK2
CSSM1-50F1K-DS	CMMD1S24-50SK2	CUM1-9F1K-DS	CMMD1S22-9SK2	CUM1-20F1K-DS	CMMD1S22-20SK2
CSSM1-50F1KL	CMMS24-50SK2030	CUM1-9F1KL	CMMS22-9SK2030	CUM1-20F1KL	CMMS22-20SK2030
CSSM1-50F1KL-DS	CMMD1S24-50SK2030	CUM1-9F1KL-DS	CMMD1S22-9SK2030	CUM1-20F1KL-DS	CMMD1S22-20SK2030
CSSM1-50F1SL	CMMS24-50SL2	CUM1-9F1SL	CMMS22-9SL2	CUM1-20F1SL	CMMS22-20SL2
CSSM1-50F1SL-DS	CMMD1S24-50SL2	CUM1-9F1SL-DS	CMMD1S22-9SL2	CUM1-20F1SL-DS	CMMD1S22-20SL2
CSSM1-50F2HRSL	CMMS24-50SKH	CUM1-9F2HRSL	CMMS22-9SKH	CUM1-20F2HRSL	CMMS22-20SKH
CSSM1-50F2HRSL-DS	CMMD1S24-50SKH	CUM1-9F2HRSL-DS	CMMD1S22-9SKH	CUM1-20F2HRSL-DS	CMMD1S22-20SKH
CSSM1-50F2K	CMMS24-50SK	CUM1-9F2K	CMMS22-9SK	CUM1-20F2K	CMMS22-20SK
CSSM1-50F2K-DS	CMMD1S24-50SK	CUM1-9F2K-DS	CMMD1S22-9SK	CUM1-20F2K-DS	CMMD1S22-20SK
CSSM1-50F2KL	CMMS24-50SK030	CUM1-9F2KL	CMMS22-9SK030	CUM1-20F2KL	CMMS22-20SK030
CSSM1-50F2KL-DS	CMMD1S24-50SK030	CUM1-9F2KL-DS	CMMD1S22-9SK030	CUM1-20F2KL-DS	CMMD1S22-20SK030
CSSM1-50F2SL	CMMS24-50SL	CUM1-9F2SL	CMMS22-9SL	CUM1-20F2SL	CMMS22-20SL
CSSM1-50F2SL-DS	CMMD1S24-50SL	CUM1-9F2SL-DS	CMMD1S22-9SL	CUM1-20F2SL-DS	CMMD1S22-20SL
CUM1-5F	CMMS22-5026	CUM1-11F	CMMS22-11026	CUM1-26F	CMMS22-26026
CUM1-5F-DS	CMMD1S22-5026	CUM1-11F-DS	CMMD1S22-11026	CUM1-26F-DS	CMMD1S22-26026
CUM1-5FHR	CMMS22-5026H	CUM1-11FHR	CMMS22-11026H	CUM1-26FHR	CMMS22-26026H
CUM1-5FHR-DS	CMMD1S22-5026H	CUM1-11FHR-DS	CMMD1S22-11026H	CUM1-26FHR-DS	CMMD1S22-26026H
CUM1-5F1HRSL	CMMS22-5SK2H	CUM1-11F1HRSL	CMMS22-11SK2H	CUM1-26F1HRSL	CMMS22-26SK2H
CUM1-5F1HRSL-DS	CMMD1S22-5SK2H	CUM1-11F1HRSL-DS	CMMD1S22-11SK2H	CUM1-26F1HRSL-DS	CMMD1S22-26SK2H
CUM1-5F1K	CMMS22-5SK2	CUM1-11F1K	CMMS22-11SK2	CUM1-26F1K	CMMS22-26SK2
CUM1-5F1K-DS	CMMD1S22-5SK2	CUM1-11F1K-DS	CMMD1S22-11SK2	CUM1-26F1K-DS	CMMD1S22-26SK2
CUM1-5F1KL	CMMS22-5SK2030	CUM1-11F1KL	CMMS22-11SK2030	CUM1-26F1KL	CMMS22-26SK2030
CUM1-5F1KL-DS	CMMD1S22-5SK2030	CUM1-11F1KL-DS	CMMD1S22-11SK2030	CUM1-26F1KL-DS	CMMD1S22-26SK2030
CUM1-5F1SL	CMMS22-5SL2	CUM1-11F1SL	CMMS22-11SL2	CUM1-26F1SL	CMMS22-26SL2
CUM1-5F1SL-DS	CMMD1S22-5SL2	CUM1-11F1SL-DS	CMMD1S22-11SL2	CUM1-26F1SL-DS	CMMD1S22-26SL2
CUM1-5F2HRSL	CMMS22-5SKH	CUM1-11F2HRSL	CMMS22-11SKH	CUM1-26F2HRSL	CMMS22-26SKH
CUM1-5F2HRSL-DS	CMMD1S22-5SKH	CUM1-11F2HRSL-DS	CMMD1S22-11SKH	CUM1-26F2HRSL-DS	CMMD1S22-26SKH
CUM1-5F2K	CMMS22-5SK	CUM1-11F2K	CMMS22-11SK	CUM1-26F2K	CMMS22-26SK
CUM1-5F2K-DS	CMMD1S22-5SK	CUM1-11F2K-DS	CMMD1S22-11SK	CUM1-26F2K-DS	CMMD1S22-26SK
CUM1-5F2KL	CMMS22-5SK030	CUM1-11F2KL	CMMS22-11SK030	CUM1-26F2KL	CMMS22-26SK030
CUM1-5F2KL-DS	CMMD1S22-5SK030	CUM1-11F2KL-DS	CMMD1S22-11SK030	CUM1-26F2KL-DS	CMMD1S22-26SK030
CUM1-5F2SL	CMMS22-5SL	CUM1-11F2SL	CMMS22-11SL	CUM1-26F2SL	CMMS22-26SL
CUM1-5F2SL-DS	CMMD1S22-5SL	CUM1-11F2SL-DS	CMMD1S22-11SL	CUM1-26F2SL-DS	CMMD1S22-26SL



# Cross Reference - U.S. Components

U.S. Components/Vishay Dale Rack and Panel  
Connectors - Microminiature, Subminiature, Miniature

Vishay Dale

U.S. COMPONENTS	VISHAY DALE	U.S. COMPONENTS	VISHAY DALE	U.S. COMPONENTS	VISHAY DALE
CSSM1-5F	CMMS24-5026	CSSM1-11F	CMMS24-11026	CSSM1-26F	CMMS24-26026
CSSM1-5F-DS	CMMD1S24-5026	CSSM1-11F-DS	CMMD1S24-11026	CSSM1-26F-DS	CMMD1S24-26026
CSSM1-5FHR	CMMS24-5026H	CSSM1-11FHR	CMMS24-11026H	CSSM1-26FHR	CMMS24-26026H
CSSM1-5FHR-DS	CMMD1S24-5026H	CSSM1-11FHR-DS	CMMD1S24-11026H	CSSM1-26FHR-DS	CMMD1S24-26026H
CSSM1-5F1HRSL	CMMS24-5SK2H	CSSM1-11F1HRSL	CMMS24-11SK2H	CSSM1-26F1HRSL	CMMS24-26SK2H
CSSM1-5F1HRSL-DS	CMMD1S24-5SK2H	CSSM1-11F1HRSL-DS	CMMD1S24-11SK2H	CSSM1-26F1HRSL-DS	CMMD1S24-26SK2H
CSSM1-5F1K	CMMS24-5SK2	CSSM1-11F1K	CMMS24-11SK2	CSSM1-26F1K	CMMS24-26SK2
CSSM1-5F1K-DS	CMMD1S24-5SK2	CSSM1-11F1K-DS	CMMD1S24-11SK2	CSSM1-26F1K-DS	CMMD1S24-26SK2
CSSM1-5F1KL	CMMS24-5SK2030	CSSM1-11F1KL	CMMS24-11SK2030	CSSM1-26F1KL	CMMS24-26SK2030
CSSM1-5F1KL-DS	CMMD1S24-5SK2030	CSSM1-11F1KL-DS	CMMD1S24-11SK2030	CSSM1-26F1KL-DS	CMMD1S24-26SK2030
CSSM1-5F1SL	CMMS24-5SL2	CSSM1-11F1SL	CMMS24-11SL2	CSSM1-26F1SL	CMMS24-26SL2
CSSM1-5F1SL-DS	CMMD1S24-5SL2	CSSM1-11F1SL-DS	CMMD1S24-11SL2	CSSM1-26F1SL-DS	CMMD1S24-26SL2
CSSM1-5F2HRSL	CMMS24-5SKH	CSSM1-11F2HRSL	CMMS24-11SKH	CSSM1-26F2HRSL	CMMS24-26SKH
CSSM1-5F2HRSL-DS	CMMD1S24-5SKH	CSSM1-11F2HRSL-DS	CMMD1S24-11SKH	CSSM1-26F2HRSL-DS	CMMD1S24-26SKH
CSSM1-5F2K	CMMS24-5SK	CSSM1-11F2K	CMMS24-11SK	CSSM1-26F2K	CMMS24-26SK
CSSM1-5F2K-DS	CMMD1S24-5SK	CSSM1-11F2K-DS	CMMD1S24-11SK	CSSM1-26F2K-DS	CMMD1S24-26SK
CSSM1-5F2KL	CMMS24-5SK030	CSSM1-11F2KL	CMMS24-11SK030	CSSM1-26F2KL	CMMS24-26SK030
CSSM1-5F2KL-DS	CMMD1S24-5SK030	CSSM1-11F2KL-DS	CMMD1S24-11SK030	CSSM1-26F2KL-DS	CMMD1S24-26SK030
CSSM1-5F2SL	CMMS24-5SL	CSSM1-11F2SL	CMMS24-11SL	CSSM1-26F2SL	CMMS24-26SL
CSSM1-5F2SL-DS	CMMD1S24-5SL	CSSM1-11F2SL-DS	CMMD1S24-11SL	CSSM1-26F2SL-DS	CMMD1S24-26SL
CSSM1-7F	CMMS24-7026	CSSM1-14F	CMMS24-14026	CSSM1-29F	CMMS24-29026
CSSM1-7F-DS	CMMD1S24-7026	CSSM1-14F-DS	CMMD1S24-14026	CSSM1-29F-DS	CMMD1S24-29026
CSSM1-7FHR	CMMS24-7026H	CSSM1-14FHR	CMMS24-14026H	CSSM1-29FHR	CMMS24-29026H
CSSM1-7FHR-DS	CMMD1S24-7026H	CSSM1-14FHR-DS	CMMD1S24-14026H	CSSM1-29FHR-DS	CMMD1S24-29026H
CSSM1-7F1HRSL	CMMS24-7SK2H	CSSM1-14F1HRSL	CMMS24-14SK2H	CSSM1-29F1HRSL	CMMS24-29SK2H
CSSM1-7F1HRSL-DS	CMMD1S24-7SK2H	CSSM1-14F1HRSL-DS	CMMD1S24-14SK2H	CSSM1-29F1HRSL-DS	CMMD1S24-29SK2H
CSSM1-7F1K	CMMS24-7SK2	CSSM1-14F1K	CMMS24-14SK2	CSSM1-29F1K	CMMS24-29SK2
CSSM1-7F1K-DS	CMMD1S24-7SK2	CSSM1-14F1K-DS	CMMD1S24-14SK2	CSSM1-29F1K-DS	CMMD1S24-29SK2
CSSM1-7F1KL	CMMS24-7SK2030	CSSM1-14F1KL	CMMS24-14SK2030	CSSM1-29F1KL	CMMS24-29SK2030
CSSM1-7F1KL-DS	CMMD1S24-7SK2030	CSSM1-14F1KL-DS	CMMD1S24-14SK2030	CSSM1-29F1KL-DS	CMMD1S24-29SK2030
CSSM1-7F1SL	CMMS24-7SL2	CSSM1-14F1SL	CMMS24-14SL2	CSSM1-29F1SL	CMMS24-29SL2
CSSM1-7F1SL-DS	CMMD1S24-7SL2	CSSM1-14F1SL-DS	CMMD1S24-14SL2	CSSM1-29F1SL-DS	CMMD1S24-29SL2
CSSM1-7F2HRSL	CMMS24-7SKH	CSSM1-14F2HRSL	CMMS24-14SKH	CSSM1-29F2HRSL	CMMS24-29SKH
CSSM1-7F2HRSL-DS	CMMD1S24-7SKH	CSSM1-14F2HRSL-DS	CMMD1S24-14SKH	CSSM1-29F2HRSL-DS	CMMD1S24-29SKH
CSSM1-7F2K	CMMS24-7SK	CSSM1-14F2K	CMMS24-14SK	CSSM1-29F2K	CMMS24-29SK
CSSM1-7F2K-DS	CMMD1S24-7SK	CSSM1-14F2K-DS	CMMD1S24-14SK	CSSM1-29F2K-DS	CMMD1S24-29SK
CSSM1-7F2KL	CMMS24-7SK030	CSSM1-14F2KL	CMMS24-14SK030	CSSM1-29F2KL	CMMS24-29SK030
CSSM1-7F2KL-DS	CMMD1S24-7SK030	CSSM1-14F2KL-DS	CMMD1S24-14SK030	CSSM1-29F2KL-DS	CMMD1S24-29SK030
CSSM1-7F2SL	CMMS24-7SL	CSSM1-14F2SL	CMMS24-14SL	CSSM1-29F2SL	CMMS24-29SL
CSSM1-7F2SL-DS	CMMD1S24-7SL	CSSM1-14F2SL-DS	CMMD1S24-14SL	CSSM1-29F2SL-DS	CMMD1S24-29SL
CSSM1-9F	CMMS24-9026	CSSM1-20F	CMMS24-20026	CSSM1-34F	CMMS24-34026
CSSM1-9F-DS	CMMD1S24-9026	CSSM1-20F-DS	CMMD1S24-20026	CSSM1-34F-DS	CMMD1S24-34026
CSSM1-9FHR	CMMS24-9026H	CSSM1-20FHR	CMMS24-20026H	CSSM1-34FHR	CMMS24-34026H
CSSM1-9FHR-DS	CMMD1S24-9026H	CSSM1-20FHR-DS	CMMD1S24-20026H	CSSM1-34FHR-DS	CMMD1S24-34026H
CSSM1-9F1HRSL	CMMS24-9SK2H	CSSM1-20F1HRSL	CMMS24-20SK2H	CSSM1-34F1HRSL	CMMS24-34SK2H
CSSM1-9F1HRSL-DS	CMMD1S24-9SK2H	CSSM1-20F1HRSL-DS	CMMD1S24-20SK2H	CSSM1-34F1HRSL-DS	CMMD1S24-34SK2H
CSSM1-9F1K	CMMS24-9SK2	CSSM1-20F1K	CMMS24-20SK2	CSSM1-34F1K	CMMS24-34SK2
CSSM1-9F1K-DS	CMMD1S24-9SK2	CSSM1-20F1K-DS	CMMD1S24-20SK2	CSSM1-34F1K-DS	CMMD1S24-34SK2
CSSM1-9F1KL	CMMS24-9SK2030	CSSM1-20F1KL	CMMS24-20SK2030	CSSM1-34F1KL	CMMS24-34SK2030
CSSM1-9F1KL-DS	CMMD1S24-9SK2030	CSSM1-20F1KL-DS	CMMD1S24-20SK2030	CSSM1-34F1KL-DS	CMMD1S24-34SK2030
CSSM1-9F1SL	CMMS24-9SL2	CSSM1-20F1SL	CMMS24-20SL2	CSSM1-34F1SL	CMMS24-34SL2
CSSM1-9F1SL-DS	CMMD1S24-9SL2	CSSM1-20F1SL-DS	CMMD1S24-20SL2	CSSM1-34F1SL-DS	CMMD1S24-34SL2
CSSM1-9F2HRSL	CMMS24-9SKH	CSSM1-20F2HRSL	CMMS24-20SKH	CSSM1-34F2HRSL	CMMS24-34SKH
CSSM1-9F2HRSL-DS	CMMD1S24-9SKH	CSSM1-20F2HRSL-DS	CMMD1S24-20SKH	CSSM1-34F2HRSL-DS	CMMD1S24-34SKH
CSSM1-9F2K	CMMS24-9SK	CSSM1-20F2K	CMMS24-20SK	CSSM1-34F2K	CMMS24-34SK
CSSM1-9F2K-DS	CMMD1S24-9SK	CSSM1-20F2K-DS	CMMD1S24-20SK	CSSM1-34F2K-DS	CMMD1S24-34SK
CSSM1-9F2KL	CMMS24-9SK030	CSSM1-20F2KL	CMMS24-20030	CSSM1-34F2KL	CMMS24-34SK030
CSSM1-9F2KL-DS	CMMD2S24-9SK030	CSSM1-20F2KL-DS	CMMD1S24-20SK030	CSSM1-34F2KL-DS	CMMD1S24-34SK030
CSSM1-9F2SL	CMMS24-9SL	CSSM1-20F2SL	CMMS24-20SL	CSSM1-34F2SL	CMMS24-34SL
CSSM1-9F2SL-DS	CMMD1S24-9SL	CSSM1-20F2SL-DS	CMMD1S24-20SL	CSSM1-34F2SL-DS	CMMD1S24-34SL



## Winchester/Vishay Dale Rack and Panel Connectors - Microminiature, Subminiature, Miniature

WINCHESTER	VISHAY DALE	WINCHESTER	VISHAY DALE	WINCHESTER	VISHAY DALE
MRA50PG	MP16-50	MRE50PG	MP20-50	SLE9PD5J	MMD1P24-9SL2L
MRA50PJ	MP16-50SL	MRE50PJ	MP20-50SL	SLE9PD5JT	MMD1P24-9SK2
MRA50PJT	MP16-50SK	MRE50PJT	MP20-50SK	SLE9PD5JT-4202	MMD1P24-9SK2
MRA50SG	MS16-50	MRE50SG	MS20-50	SLE9PD5JTU	MMD1P24-9SK2030
MRA50SJ	MS16-50SL	MRE50SJ	MS20-50SL	SLE9PD5NSS	MMD1P24-9027
MRA50SJT	MS16-50SK	MRE50SJT	MS20-50SK	SLE9PJ	MMP24-9SL2L
MRA75PG	MP16-75	MRE75PG	MP20-75	SLE9PJT	MMP24-9SK2
MRA75PJ	MP16-75SL	MRE75PJ	MP20-75SL	SLE9PJT-4202	MMP24-9SK2
MRA75PJT	MP16-75SK	MRE75PJT	MP20-75SK	SLE9PJTU	MMP24-9SK2030
MRA75SG	MS16-75	MRE75SG	MS20-75	SLE9PNSS	MMP24-9027
MRA75SJ	MS16-75SL	MRE75SJ	MS20-75SL	SLE9SD5J	MMD1S24-9SL2L
MRA75SJT	MS16-75SK	MRE75SJT	MS20-75SK	SLE9SD5JT	MMD1S24-9SK2
MRE7PG	MP20-7	SLE5PD5J	MMD1P24-5SL2L	SLE9SD5JT-4202	MMD1S24-9SK2
MRE7PJ	MP20-7SL	SLE5PD5JT	MMD1P24-5SK2	SLE9SD5JTU	MMD1S24-9SK2030
MRE7PJT	MP20-7SK	SLE5PD5JT-4202	MMD1P24-5SK2	SLE9SD5NSS	MMD1S24-9027
MRE7SG	MS20-7	SLE5PD5JTU	MMD1P24-5SK2030	SLE9SJ	MMS24-9SL27
MRE7SJ	MS20-7SL	SLE5PD5NSS	MMD1P24-5027	SLE9SJT	MMS24-9SK2
MRE7SJT	MS20-7SK	SLE5PJ	MMP24-5SL2L	SLE9SJT-4202	MMS24-9SK2
MRE9PG	MP20-9	SLE5PJT	MMP24-5SK2	SLE9SJTU	MMS24-9SK2030
MRE9PJ	MP20-9SL	SLE5PJT-4202	MMP24-5SK2	SLE9SNSS	MMS24-9027
MRE9PJT	MP20-9SK	SLE5PJTU	MMP24-5SK2030	SLE11PD5J	MMD1P24-11SL2L
MRE9SG	MS20-9	SLE5PNSS	MMP24-5027	SLE11PD5JT	MMD1P24-11SK2
MRE9SJ	MS20-9SL	SLE5SD5J	MMD1S24-5SL2L	SLE11PD5JT-4202	MMD1P24-11SK2
MRE9SJT	MS20-9SK	SLE5SD5JT	MMD1S24-5SK2	SLE11PD5JTCH8	MMD1P24-11SK2H
MRE14PG	MP20-14	SLE5SD5JT-4202	MMD1S24-5SK2	SLE11PD5JTU	MMD1P24-11SK2030
MRE14PJ	MP20-14SL	SLE5SD5JTU	MMD1S24-5SK2030	SLE11PD5NSS	MMD1P24-11027
MRE14PJT	MP20-14SK	SLE5SD5NSS	MMD1S24-5027	SLE11PD5NSSH8	MMD1P24-11027H
MRE14SG	MS20-14	SLE5SJ	MMS24-5SL2L	SLE11PJ	MMP24-11SL2L
MRE14SJ	MS20-14SL	SLE5SJT	MMS24-5SK2	SLE11PJT	MMP24-11SK2
MRE14SJT	MS20-14SK	SLE5SJT-4202	MMS24-5SK2	SLE11PJT-4202	MMP24-11SK2
MRE18PG	MP20-18	SLE5SJTU	MMS24-5SK2030	SLE11PJTCH8	MMP24-11SK2H
MRE18PJ	MP20-18SL	SLE5SNSS	MMS24-5027	SLE11PJTU	MMP24-11SK2030
MRE18PJT	MP20-18SK	SLE7PD5J	MMD1P24-7SL2L	SLE11PNSS	MMP24-11027
MRE18SG	MS20-18	SLE7PD5JT	MMD1P24-7SK2	SLE11PNSSH8	MMP24-11027H
MRE18SJ	MS20-18SL	SLE7PD5JT-4202	MMD1P24-7SK2	SLE11SD5J	MMD1P24-11SL2L
MRE18SJT	MS20-18SK	SLE7PD5JTCH13	MMD1P24-7SK2H	SLE11SD5JT	MMD1S24-11SK2
MRE20PG	MP20-20	SLE7PD5JTU	MMD1P24-7SK2030	SLE11SD5JT-4202	MMD1S24-11SK2
MRE20PJ	MP20-20SL	SLE7PD5NSS	MMD1P24-7027	SLE11SD5JTCH8	MMD1S24-11SK2H
MRE20PJT	MP20-20SK	SLE7PD5NSSH13	MMD1P24-7027H	SLE11SD5JTU	MMD1S24-11SK2030
MRE20SG	MS20-20	SLE7PJ	MMP24-7SL2L	SLE11SD5NSS	MMD1S24-11027
MRE20SJ	MS20-20SL	SLE7PJT	MMP24-7SK2	SLE11SD5NSSH8	MMD1S24-11027H
MRE20SJT	MS20-20SK	SLE7PJT-4202	MMP24-7SK2	SLE11SJ	MMS24-11SL2L
MRE26PG	MP20-26	SLE7PJTCH13	MMP24-7SK2H	SLE11SJT	MMS24-11SK2
MRE26PJ	MP20-26SL	SLE7PJTU	MMP24-7SK2030	SLE11SJT-4202	MMS24-11SK2
MRE26PJT	MP20-26SK	SLE7PNSS	MMP24-7027	SLE11SJTCH8	MMS24-11SK2H
MRE26SG	MS20-26	SLE7PNSSH13	MMP24-7027H	SLE11SJTU	MMS24-11SK2030
MRE26SJ	MS20-26SL	SLE7SD5J	MMD1S24-7SL2L	SLE11SNSS	MMS24-11027
MRE26SJT	MS20-26SK	SLE7SD5JT	MMD1S24-7SK2	SLE11SNSSH8	MMS24-11027H
MRE34PG	MP20-34	SLE7SD5JT-4202	MMD1S24-7SK2	SLE14PD5J	MMD1P24-14SL2L
MRE34PJ	MP20-34SL	SLE7SD5JTCH13	MMD1S24-7SK2H	SLE14PD5JT	MMD1P24-14SK2
MRE34PJT	MP20-34SK	SLE7SD5JTU	MMD1S24-7SK2030	SLE14PD5JT-4202	MMD1P24-14SK2
MRE34SG	MS20-34	SLE7SD5NSS	MMD1S24-7027	SLE14PD5JTCH13	MMD1P24-14SK2H
MRE34SJ	MS20-34SL	SLE7SD5NSSH13	MMD1S24-7027H	SLE14PD5JTU	MMD1P24-14SK2030
MRE34SJT	MS20-34SK	SLE7SJ	MMS24-7SL2L	SLE14PD5NSS	MMD1P24-14027
MRE41PG	MP20-41	SLE7SJT	MMS24-7SK2	SLE14PD5NSSH13	MMD1P24-14027H
MRE41PJ	MP20-41SL	SLE7SJT-4202	MMS24-7SK2	SLE14PJ	MMP24-14SL2L
MRE41PJT	MP20-41SK	SLE7SJTCH13	MMS24-7SK2H	SLE14PJT	MMP24-14SK2
MRE41SG	MS20-41	SLE7SJTU	MMS24-7SK2030	SLE14PJT-4202	MMP24-14SK2
MRE41SJ	MS20-41SL	SLE7SNSS	MMS24-7027	SLE14PJTCH13	MMP24-14SK2H
MRE41SJT	MS20-41SK	SLE7SNSSH13	MMS24-7027H	SLE14PJTU	MMP24-14SK2030



# Cross Reference - Winchester

Winchester/Vishay Dale Rack and Panel Connectors -  
Microminiature, Subminiature, Miniature

Vishay Dale

WINCHESTER	VISHAY DALE	WINCHESTER	VISHAY DALE	WINCHESTER	VISHAY DALE
SLE14PNSS	MMP24-14027	SLE26SD5JT-4202	MMD1S24-26SK2	SLE44PD5J	MMD1P24-44SL2L
SLE14PNSSH13	MMP24-14027H	SLE26SD5JTCH13	MMD1S24-26SK2H	SLE44PD5JT	MMD1P24-44SK2
SLE14SD5J	MMD1S24-14SL2L	SLE26SD5JTU	MMD1S24-26SK2030	SLE44PD5JT-4202	MMD1P24-44SK2
SLE14SD5JT	MMD1S24-14SK2	SLE26SD5NSS	MMD1S24-26027	SLE44PD5JTU	MMD1P24-44SK2030
SLE14SD5JT-4202	MMD1S24-14SK2	SLE26SD5NSSH13	MMD1S24-26027H	SLE44PD5NSS	MMD1P24-44027
SLE14SD5JTCH13	MMD1S24-14SK2H	SLE26SJ	MMS24-26SL2L	SLE44PJ	MMP24-44SL2L
SLE14SD5JTU	MMD1S24-14SK2030	SLE26SJT	MMS24-26SK2	SLE44PJT	MMP24-44SK2
SLE14SD5NSS	MMD1S24-14027	SLE26SJT-4202	MMS24-26SK2	SLE44PJT-4202	MMP24-44SK2
SLE14SD5NSSH13	MMD1S24-14027H	SLE26SJTCH13	MMS24-26SK2H	SLE44PJTU	MMP24-44SK2030
SLE14SJ	MMS24-14SL2L	SLE26SJTU	MMS24-26SK2030	SLE44PNSS	MMP24-44027
SLE14SJT	MMS24-14SK2	SLE26SNSS	MMS24-26027	SLE44SD5J	MMD1S24-44SL2L
SLE14SJT-4202	MMS24-14SK2	SLE26SNSSH13	MMS24-26027H	SLE44SD5JT	MMD1S24-44SK2
SLE14SJTCH13	MMS24-14SK2H	SLE29PD5J	MMD1P24-29SL2L	SLE44SD5JT-4202	MMD1S24-44SK2
SLE14SJTU	MMS24-14SK2030	SLE29PD5JT	MMD1P24-29SK2	SLE44SD5JTU	MMD1S24-44SK2030
SLE14SNSS	MMS24-14027	SLE29PD5JT-4202	MMD1P24-29SK2	SLE44SD5NSS	MMD1S24-44027
SLE14SNSSH13	MMS24-14027H	SLE29PD5JTU	MMD1P24-29SK2030	SLE44SJ	MMS24-44SL2L
SLE20PD5J	MMD1P24-20SL2L	SLE29PD5NSS	MMD1P24-29027	SLE44SJT	MMS24-44SK2
SLE20PD5JT	MMD1P24-20SK2	SLE29PJ	MMP24-29SL2L	SLE44SJT-4202	MMS24-44SK2
SLE20PD5JT-4202	MMD1P24-20SK2	SLE29PJT	MMP24-29SK2	SLE44SJTU	MMS24-44SK2030
SLE20PD5JTCH13	MMD1P24-20SK2H	SLE29PJT-4202	MMP24-29SK2	SLE44SNSS	MMS24-44027
SLE20PD5JTU	MMD1P24-20SK2030	SLE29PJTU	MMP24-29SK2030	SLE50PD5J	MMD1P24-50SL2L
SLE20PD5NSS	MMD1P24-20027	SLE29PNSS	MMP24-29027	SLE50PD5JT	MMD1P24-50SK2
SLE20PD5NSSH13	MMD1P24-20027H	SLE29SD5J	MMD1S24-29SL2L	SLE50PD5JT-4202	MMD1P24-50SK2
SLE20PJ	MMP24-20SL2L	SLE29SD5JT	MMD1S24-29SK2	SLE50PD5JTCH8	MMD1P24-50SK2H
SLE20PJT	MMP24-20SK2	SLE29SD5JT-4202	MMD1S24-29SK2	SLE50PD5JTU	MMD1P24-50SK2030
SLE20PJT-4202	MMP24-20SK2	SLE29SD5JTU	MMD1S24-29SK2030	SLE50PD5NSS	MMD1P24-50027
SLE20PJTCH13	MMP24-20SK2H	SLE29SD5NSS	MMD1S24-29027	SLE50PD5NSSH8	MMD1P24-50027H
SLE20PJTU	MMP24-20SK2030	SLE29SJ	MMS24-29SL2L	SLE50PJ	MMP24-50SL2L
SLE20PNSS	MMP24-20027	SLE29SJT	MMS24-29SK2	SLE50PJT	MMP24-50SK2
SLE20PNSSH13	MMP24-20027H	SLE29SJ-4202	MMS24-29SK2	SLE50PJT-4202	MMP24-50SK2
SLE20SD5J	MMD1S24-20SL2L	SLE29SJTU	MMS24-29SK2030	SLE50PJTCH8	MMP24-50SK2H
SLE20SD5JT	MMD1S24-20SK2	SLE29SNSS	MMS24-29027	SLE50PJTU	MMP24-50SK2030
SLE20SD5JT-4202	MMD1S24-20SK2	SLE34PD5J	MMD1P24-34SL2L	SLE50PNSS	MMP24-50027
SLE20SD5JTCH13	MMD1S24-20SK2H	SLE34PD5JT	MMD1P24-34SK2	SLE50PNSSH8	MMP24-50027H
SLE20SD5JTU	MMD1S24-20SK2030	SLE34PD5JT-4202	MMD1P24-34SK2	SLE50SD5J	MMD1S24-50SL2L
SLE20SD5NSS	MMD1S24-20027	SLE34PD5JTCH13	MMD1P24-34SK2H	SLE50SD5JT	MMD1S24-50SK2
SLE20SD5NSSH13	MMD1S24-20027H	SLE34PD5JTU	MMD1P24-34SK2030	SLE50SD5JT-4202	MMD1S24-50SK2
SLE20SJ	MMS24-20SL2L	SLE34PD5NSS	MMD1P24-34027	SLE50SD5JTCH8	MMD1S24-50SK2H
SLE20SJT	MMS24-20SK2	SLE34PD5NSSH13	MMD1P24-34027H	SLE50SD5JTU	MMD1S24-50SK2030
SLE20SJT-4202	MMS24-20SK2	SLE34PJ	MMP24-34SL2L	SLE50SD5NSS	MMD1S24-50027
SLE20SJTCH13	MMS24-20SK2H	SLE34PJT	MMP24-34SK2	SLE50SD5NSSH8	MMD1S24-50027H
SLE20SJTU	MMS24-20SK2030	SLE24PJT-4202	MMP24-34SK2	SLE50SJ	MMS24-50SL2L
SLE20SNSS	MMS24-20027	SLE34PJTCH13	MMP24-34SK2H	SLE50SJT	MMS24-50SK2
SLE20SNSSH13	MMS24-20027H	SLE34PJTU	MMP24-34SK2030	SLE50SJT-4202	MMS24-50SK2
SLE26PD5J	MMD1P24-26SL2L	SLE34PJNSS	MMP24-34027	SLE50SJTCH8	MMS24-50SK2H
SLE26PD5JT	MMD1P24-26SK2	SLE34PJNSSH13	MMP24-34027H	SLE50SJTU	MMS24-50SK2030
SLE26PD5JT-4202	MMD1P24-26SK2	SLE34SD5J	MMD1S24-34SL2L	SLE50SNSS	MMS24-50027
SLE26PD5JTCH13	MMD1P24-26SK2H	SLE34SD5JT	MMD1S24-34SK2	SLE50SNSSH8	MMS24-50027H
SLE26PD5JTU	MMD1P24-26SK2030	SLE34SD5JT-4202	MMD1S24-34SK2	SRE5PD5J	MMD1P22-5SLL
SLE26PD5NSS	MMD1P24-26027	SLE34SD5JTCH13	MMD1S24-34SK2H	SRE5PD5JT	MMD1P22-5SK
SLE26PD5NSSH13	MMD1P24-26027H	SLE34SD5JTU	MMD1S24-34SK2030	SRE5PD5JT-4202	MMD1P22-5SK
SLE26PJ	MMP24-26SL2L	SLE34SD5NSS	MMD1S24-34027	SRE5PD5JTU	MMD1P22-5SK030
SLE26PJT	MMP24-26SK2	SLE34SD5NSSH13	MMD1S24-34027H	SRE5PD5NSS	MMD1P22-5027
SLE26PJT-4202	MMP24-26SK2	SLE34SJ	MMS24-34SL2L	SRE5PJ	MMP22-5SLL
SLE26PJTCH13	MMP24-26SK2H	SLE34SJT	MMS24-34SK2	SRE5PJT	MMP22-5SK
SLE26PJTU	MMP24-26SK2030	SLE34SJT-4202	MMS24-34SK2	SRE5PJT-4202	MMP22-5SK
SLE26PNSS	MMP24-26027	SLE34SJTCH13	MMS24-34SK2H	SRE5PJTU	MMP22-5SK2030
SLE26PNSSH13	MMP24-26027H	SLE34SJTU	MMS24-34SK2030	SRE5PNSS	MMP22-5027
SLE26SD5J	MMD1S24-26SL2L	SLE34SNSS	MMS24-34027	SRE5SD5J	MMD1S22-5SLL
SLE26SD5JT	MMD1S24-26SK2	SLE34SNSSH13	MMS24-34027H	SRE5SD5JT	MMD1S22-5SK

# Cross Reference - Winchester



Vishay Dale Winchester/Vishay Dale Rack and Panel Connectors -  
Microminiature, Subminiature, Miniature

WINCHESTER	VISHAY DALE	WINCHESTER	VISHAY DALE	WINCHESTER	VISHAY DALE
SRE5SD5JT-4202	MMD1S22-5SK	SRE11PD5JTU	MMD1P22-11SK030	SRE20PJT	MMP22-20SK
SRE5SD5JTU	MMD1S22-5SK030	SRE11PD5NSS	MMD1P22-11027	SRE20PJT-4202	MMP22-20SK
SRE5SD5NSS	MMD1S22-5027	SRE11PD5NSSH8	MMD1P22-11027H	SRE20PJTCH13	MMP22-20SKH
SRE5SJ	MMS22-5SLL	SRE11PJ	MMP22-11SL	SRE20PJTU	MMP22-20SK030
SRE5SJT	MMS22-5SK	SRE11PJT	MMP22-11SK	SRE20PNSS	MMP22-20027
SRE5SJT-4202	MMS22-5SK	SRE11PJT-4202	MMP22-11SK	SRE20PNSSH13	MMP22-20027H
SRE5SJTU	MMS22-5SK030	SRE11PJTCH8	MMP22-11SKH	SRE20SD5J	MMD1S22-20SLL
SRE5SNSS	MMS22-5027	SRE11PJTU	MMP22-11SK030	SRE20SD5JT	MMD1S22-20SK
SRE7PD5J	MMD1P22-7SLL	SRE11PNSS	MMP22-11027	SRE20SD5JT-4202	MMD1S22-20SK
SRE7PD5JT	MMD1P22-7SK	SRE11PNSSH8	MMP22-11027H	SRE20SD5JTCH13	MMD1S22-20SKH
SRE7PD5JT-4202	MMD1P22-7SK	SRE11SD5J	MMD1S22-11SLL	SRE20SD5JTU	MMD1S22-20SK030
SRE7PD5JTCH13	MMD1P22-7SKH	SRE11SD5JT	MMD1S22-11SK	SRE20SD5NSS	MMD1S22-20027
SRE7PD5JTU	MMD1P22-7SK030	SRE11SD5JT-4202	MMD1S22-11SK	SRE20SD5NSSH13	MMD1S22-20027H
SRE7PD5NSS	MMD1P22-7027	SRE11SD5JTCH8	MMD1S22-11SKH	SRE20SJ	MMD1S22-20SLL
SRE7PD5NSSH13	MMD1P22-7027H	SRE11SD5JTU	MMD1S22-11SK030	SRE20SJT	MMS22-20SK
SRE7PJ	MMP22-7SLL	SRE11SD5NSS	MMD1S22-11027	SRE20SJT-4202	MMS22-20SK
SRE7PJT	MMP22-7SK	SRE11SD5NSSH8	MMD1S22-11027H	SRE20SJTCH13	MMS22-20SKH
SRE7PJT-4202	MMP22-7SK	SRE11SJ	MMS22-11SLL	SRE20SJTU	MMS22-20SK030
SRE7PJTCH13	MMP22-7SKH	SRE11SJT	MMS22-11SK	SRE20SNSS	MMS22-20027
SRE7PJTU	MMP22-7SK030	SRE11SJT-4202	MMS22-11SK	SRE20SNSSH13	MMS22-20027H
SRE7PNSS	MMP22-7027	SRE11SJTCH8	MMS22-11SKH	SRE26PD5J	MMD1P22-26SLL
SRE7PNSSH13	MMP22-7027H	SRE11SJTU	MMS22-11SK030	SRE26PD5JT	MMD1P22-26SK
SRE7SD5J	MMD1S22-7SLL	SRE11SNSS	MMS22-11027	SRE26PD5JT-4202	MMD1P22-26SK
SRE7SD5JT	MMD1S22-7SK	SRE11SNSSH8	MMS22-11027H	SRE26PD5JTCH13	MMD1P22-26SKH
SRE7SD5JT-4202	MMD1S22-7SK	SRE14PD5J	MMD1P22-14SLL	SRE26PD5JTU	MMD1P22-26SK030
SRE7SD5JTCH13	MMD1S22-7SKH	SRE14PD5JT	MMD1P22-14SK	SRE26PD5NSS	MMD1P22-26027
SRE7SD5JTU	MMD1S22-7SK030	SRE14PD5JT-4202	MMD1P22-14SK	SRE26PD5NSSH13	MMD1P22-26027H
SRE7SD5NSS	MMD1S22-7027	SRE14PD5JTCH13	MMD1P22-14SKH	SRE26PJ	MMP22-26SLL
SRE7SD5NSSH13	MMD1S22-7027H	SRE14PD5JTU	MMD1P22-14SK030	SRE26PJT	MMP22-26SK
SRE7SJ	MMS22-7SLL	SRE14PD5NSS	MMD1P22-14027	SRE26PJT-4202	MMP22-26SK
SRE7SJT	MMS22-7SK	SRE14PD5NSSH13	MMD1P22-14027H	SRE26PJTCH13	MMP22-26SKH
SRE7SJT-4202	MMS22-7SK	SRE14PJ	MMP22-14SLL	SRE26PJTU	MMP22-26SK030
SRE7SJTCH13	MMS22-7SKH	SRE14PJT	MMP22-14SK	SRE26PNSS	MMP22-26027
SRE7SJTU	MMS22-7SK030	SRE14PJT-4202	MMP22-14SK	SRE26PNSSH13	MMP22-26027H
SRE7SNSS	MMS22-7027	SRE14PJTCH13	MMP22-14SKH	SRE26SD5J	MMD1S22-26SLL
SRE7SNSSH13	MMS22-7027H	SRE14PJTU	MMP22-14SK030	SRE26SD5JT	MMD1S22-26SK
SRE9PD5J	MMD1P22-9SLL	SRE14PNSS	MMP22-14027	SRE26SD5JT-4202	MMD1S22-26SK
SRE9PD5JT	MMD1P22-9SK	SRE14PNSSH13	MMP22-14027H	SRE26SD5JTCH13	MMD1S22-26SKH
SRE9PD5JT-4202	MMD1P22-9SK	SRE14SD5J	MMD1S22-14SLL	SRE26SD5JTU	MMD1S22-26SK030
SRE9PD5JTU	MMD1P22-9SK030	SRE14SD5JT	MMD1S22-14SK	SRE26SD5NSS	MMD1S22-26027
SRE9PD5NSS	MMD1P22-9027	SRE14SD5JT-4202	MMD1S22-14SK2	SRE26SD5NSSH13	MMD1S22-26027H
SRE9PJ	MMP22-9SLL	SRE14SD5JTCH13	MMD1S22-14SK2H	SRE26SJ	MMS22-26SLL
SRE9PJT	MMP22-9SK	SRE14SD5JTU	MMD1S22-14SK030	SRE26SJT	MMS22-26SK
SRE9PJT-4202	MMP22-9SK	SRE14SD5NSS	MMD1S22-14027	SRE26SJT-4202	MMS22-26SK
SRE9PJTU	MMP22-9SK030	SRE14SD5NSSH13	MMD1S22-14027H	SRE26SJTCH13	MMS22-26SKH
SRE9PNSS	MMP22-9027	SRE14SJ	MMS22-14SLL	SRE26SJTU	MMS22-26SK030
SRE9SD5J	MMD1S22-9SLL	SRE14SJT	MMS22-14SK	SRE26SNSS	MMS22-26027
SRE9SD5JT	MMD1S22-9SK	SRE14SJT-4202	MMS22-14SK	SRE26SNSSH13	MMS22-26027H
SRE9SD5JT-4202	MMD1S22-9SK	SRE14SJTCH13	MMS22-14SKH	SRE29PD5J	MMD1P22-29SLL
SRE9SD5JTU	MMD1S22-9SK030	SRE14SJTU	MMS22-14SK030	SRE29PD5JT	MMD1P22-29SK
SRE9SD5NSS	MMD1S22-9027	SRE14SNSS	MMS22-14027	SRE29PD5JT-4202	MMD1P22-29SK
SRE9SJ	MMS22-9SLL	SRE14SNSSH13	MMS22-14027H	SRE29PD5JTU	MMD1P22-29SK030
SRE9SJT	MMS22-9SK	SRE20PD5J	MMD1P22-20SLL	SRE29PD5NSS	MMD1P22-26027
SRE9SJT-4202	MMS22-9SK	SRE20PD5JT	MMD1P22-20SK	SRE29PJ	MMP22-29SLL
SRE9SJTU	MMS22-9SK030	SRE20PD5JT-4202	MMD1P22-20SK	SRE29PJT	MMP22-29SK
SRE9SNSS	MMS22-9027	SRE20PD5JTCH13	MMD1P22-20SKH	SRE29PJT-4202	MMP22-29SK
SRE11PD5J	MMD1P22-11SLL	SRE20PD5JTU	MMD1P22-20SK030	SRE29PJTU	MMP22-29SK030
SRE11PD5JT	MMD1P22-11SK	SRE20PD5NSS	MMD1P22-20027	SRE29PNSS	MMP22-29027
SRE11PD5JT-4202	MMD1P22-11SK	SRE20PD5NSSH13	MMD1P22-20027H	SRE29SD5J	MMD1S22-29SLL
SRE11PD5JTCH8	MMD1P22-11SKH	SRE20PJ	MMP22-20SLL	SRE29SD5JT	MMD1S22-29SK



# Cross Reference - Winchester

Winchester/Vishay Dale Rack and Panel Connectors -  
Microminiature, Subminiature, Miniature

Vishay Dale

WINCHESTER	VISHAY DALE	WINCHESTER	VISHAY DALE	WINCHESTER	VISHAY DALE
SRE29SD5JT-4202	MMD1S22-29SK	SRE50PD5JTU	MMD1P22-50SK030	SRM7SC0300	SMS20-7SKH
SRE29SD5JTU	MMD1S22-29SK030	SRE50PD5NSS	MMD1P22-50027	SRM7SC0400	SMS20-7SKH1
SRE29SD5NSS	MMD1S22-29027	SRE50PD5NSSH8	MMD1P22-50027H	SRM7SDC0300	SMDS20-7SKH
SRE29SJ	MMS22-29SLL	SRE50PJ	MMP22-50SLL	SRM7SDC0400	SMDS20-7SKH1
SRE29SJT	MMS22-29SK	SRE50PJT	MMP22-50SK	SRM7SDF0000	SMDS20-7SL
SRE29SJT-4202	MMS22-29SK	SRE50PJT-4202	MMP22-50SK	SRM7SDM0000	SMDS20-7SK
SRE29SJTU	MMS22-29SK030	SRE50PJTCH8	MMP22-50SKH	SRM7SDN0000	SMDS20-7026
SRE29SNSS	MMSP22-29027	SRE50PJTU	MMP22-50SK030	SRM7SDN0500	SMDS20-7026H
SRE34PD5J	MMD1P22-34SLL	SRE50PNSS	MMP22-50027	SRM7SDN0600	SMDS20-7026H1
SRE34PD5JT	MMD1P22-34SK	SRE50PNSSH8	MMP22-50027H	SRM7SDNSS0000	SMDS20-7027
SRE34PD5JT-4202	MMD1P22-34SK	SRE50SD5J	MMD1S22-50SLL	SRM7SDNSS0500	SMDS20-7027H
SRE34PD5JTCH13	MMD1P22-34SKH	SRE50SD5JT	MMD1S22-50SK	SRM7SDNSS0600	SMDS20-7027H1
SRE34PD5JTU	MMD1P22-34SK030	SRE50SD5JT-4202	MMD1S22-50SK	SRM7SF0000	SMS20-7SL
SRE34PD5NSS	MMD1P22-34027	SRE50SD5JTCH8	MMD1S22-50SKH	SRM7SM0000	SMS20-7SK
SRE34PD5NSSH13	MMD1P22-34027H	SRE50SD5JTU	MMD1S22-50SK030	SRM7SN0000	SMS20-7026
SRE34PJ	MMP22-34SLL	SRE50SD5NSS	MMD1S22-50027	SRM7SN0500	SMS20-7026H
SRE34PJT	MMP22-34SK	SRE50SD5NSSH8	MMD1S22-50027H	SRM7SN0600	SMS20-7026H1
SRE34PJT-4202	MMP22-34SK	SRE50SJ	MMS22-50SLL	SRM7SNSS0000	SMS20-7027
SRE34PJTCH13	MMP22-34SKH	SRE50SJT	MMS22-50SK	SRM7SNSS0500	SMS20-7027H
SRE34PJTU	MMP22-34SK030	SRE50SJT-4202	MMS22-50SK	SRM7SNSS0600	SMS20-7027H1
SRE34PNSS	MMP22-34027	SRE50SJTCH8	MMS22-50SKH	SRM11PC0300	SMS20-11SKH
SRE34PNSSH13	MMP22-34027H	SRE50SJTU	MMS22-50SK030	SRM11PC0400	SMS20-11SKH1
SRE34SD5J	MMD1S22-34SLL	SRE50SNSS	MMS22-50027	SRM11PDC0300	SMDS20-P11SKH
SRE34SD5JT	MMD1S22-34SK	SRE50SNSSH8	MMS22-50027H	SRM11PDC0400	SMDS20-P11SKH1
SRE34SD5JT-4202	MMD1S22-34SK	SRM5PDF0000	SMDP20-5SL	SRM11PDF0000	SMDP20-11SL
SRE34SD5JTCH13	MMD1S22-34SKH	SRM5PDM0000	SMDP20-5SK	SRM11PDM0000	SMDP20-11SK
SRE34SD5JTU	MMD1S22-34SK030	SRM5PDN0000	SMDP20-5026	SRM11PDN0000	SMDP20-11026
SRE34SD5NSS	MMD1S22-34027	SRM5PDNSS0000	SMDP20-5027	SRM11PDN0500	SMDP20-11026H
SRE34SD5NSSH13	MMD1S22-34027H	SRM5PF0000	SMP20-5SL	SRM11PDN0600	SMDP20-11026H1
SRE34SJ	MMS22-34SLL	SRM5PM0000	SMP20-5SK	SRM11PDNSS0000	SMDP20-11027
SRE34SJT	MMS22-34SK	SRM5PN0000	SMP20-5026	SRM11PDNSS0500	SMDP20-11027H
SRE34SJT-4202	MMS22-34SK	SRM5PNSS0000	SMP20-5027	SRM11PDNSS0600	SMDP20-11027H1
SRE34SJTCH13	MMS22-34SKH	SRM5SDF0000	SMP20-5SL	SRM11PF0000	SMP20-11SL
SRE34SJTU	MMS22-34SK030	SRM5SDM0000	SMP20-5SK	SRM11PM0000	SMP20-11SK
SRE34SNSS	MMS22-34027	SRM5SDN0000	SMP20-5026	SRM11PN0000	SMP20-11026
SRE34SNSSH13	MMS22-34027H	SRM5SDNSS0000	SMP20-5027	SRM11PN0500	SMP20-11026H
SRE44PD5J	MMD1P22-44SLL	SRM5SF0000	SMS20-5SL	SRM11PN0600	SMP20-11026H1
SRE44PD5JT	MMD1P22-44SK	SRM5SM0000	SMS20-5SK	SRM11PNSS0000	SMP20-11027
SRE44PD5JT-4202	MMD1P22-44SK	SRM5SN0000	SMS20-5026	SRM11PNSS0500	SMP20-11027H
SRE44PD5JTU	MMD1P22-44SK030	SRM5SNSS0000	SMS20-5027	SRM11PNSS0600	SMP20-11027H1
SRE44PD5NSS	MMD1P22-44027	SRM7PC0300	SMP20-7SKH	SRM11SC0300	SMS20-11SKH
SRE44PJ	MMP22-44SLL	SRM7PC0400	SMP20-7SKH1	SRM11SC0400	SMS20-11SKH1
SRE44PJT	MMP22-44SK	SRM7PDC0300	SMDP20-7SKH	SRM11SDC0300	SMDS20-11SKH
SRE44PJT-4202	MMP22-44SK	SRM7PDC0400	SMDP20-7SKH1	SRM11SDC0400	SMDS20-11SKH1
SRE44PJTU	MMP22-44SK030	SRM7PDF0000	SMDP20-7SL	SRM11SDF0000	SMDS20-11SL
SRE44PNSS	MMP22-44027	SRM7PDM0000	SMDP20-7SK	SRM11SDM0000	SMDS20-11SK
SRE44SD5J	MMD1S22-44SLL	SRM7PDN0000	SMDP20-7026	SRM11SDN0000	SMDS20-11026
SRE44SD5JT	MMD1S22-44SK	SRM7PDN0500	SMDP20-7026H	SRM11SDN0500	SMDS20-11026H
SRE44SD5JT-4202	MMD1S22-44SK	SRM7PDN0600	SMDP20-7026H1	SRM11SDN0600	SMDS20-11026H1
SRE44SD5JTU	MMD1S22-44SK030	SRM7PDNSS0000	SMDP20-7027	SRM11SDNSS0000	SMDS20-11027
SRE44SD5NSS	MMD1S22-44027	SRM7PDNSS0500	SMDP20-7027H	SRM11SDNSS0500	SMDS20-11027H
SRE44SJ	MMS22-44SLL	SRM7PDNSS0600	SMDP20-7027H1	SRM11SDNSS0600	SMDS20-11027H1
SRE44SJT	MMS22-44SK	SRM7PF0000	SMP20-7SL	SRM11SF0000	SMS20-11SL
SRE44SJT-4202	MMS22-44SK	SRM7PM0000	SMP20-7SK	SRM11SM0000	SMS20-11SK
SRE44SJTU	MMS22-44SK2030	SRM7PN0000	SMP20-7026	SRM11SN0000	SMS20-11026
SRE44SNSS	MMS22-44027	SRM7PN0500	SMP20-7026H	SRM11SN0500	SMS20-11026H
SRE50PD5J	MMD1P22-50SLL	SRM7PN0600	SMP20-7026H1	SRM11SN0600	SMS20-11026H1
SRE50PD5JT	MMD1P22-50SK	SRM7PNSS0000	SMP20-7027	SRM11SNSS0000	SMS20-11027
SRE50PD5JT-4202	MMD1P22-50SK	SRM7PNSS0500	SMP20-7027H	SRM11SNSS0500	SMS20-11027H
SRE50PD5JTCH8	MMD1P22-50SKH	SRM7PNSS0600	SMP20-7027H1	SRM11SNSS0600	SMS20-11027H1



# Cross Reference - Winchester



Vishay Dale Winchester/Vishay Dale Rack and Panel Connectors -  
Microminiature, Subminiature, Miniature

WINCHESTER	VISHAY DALE	WINCHESTER	VISHAY DALE	WINCHESTER	VISHAY DALE
SRM14PC0300	SMP20-14SKH	SRM20SC0300	SMS20-SKH	SRM34PC0300	SMP20-34SKH
SRM14PC0400	SMP20-14SKH1	SRM20SC0400	SMS20-SKH1	SRM34PC0400	SMP20-34SKH1
SRM14PDC0300	SMDP20-14SKH	SRM20SDC0300	SMDS20-SKH	SRM34PDC0300	SMDP20-34SKH
SRM14PDC0400	SMDP20-14SKH1	SRM20SDC0400	SMDS20-SKH1	SRM34PDC0400	SMDP20-34SKH1
SRM14PDF0000	SMDP20-14SL	SRM20SDF0000	SMDS20-20SL	SRM34PDF0000	SMDP20-34SL
SRM14PDM0000	SMDP20-14SK	SRM20SDM0000	SMDS20-20SK	SRM34PDM0000	SMDP20-34SK
SRM14PDN0000	SMDP20-14026	SRM20SDN0000	SMDS20-20026	SRM34PDN0000	SMDP20-34026
SRM14PDN0500	SMDP20-14026H	SRM20SDN0500	SMDS20-026H	SRM34PDN0500	SMDP20-34026H
SRM14PDN0600	SMDP20-14026H1	SRM20SDN0600	SMDS20-026H1	SRM34PDN0600	SMDP20-34026H1
SRM14PDNSS0000	SMDP20-14027	SRM20SDNSS0000	SMDS20-20027	SRM34PDNSS0000	SMDP20-34027
SRM14PDNSS0500	SMDP20-14027H	SRM20SDNSS0500	SMDS20-027H	SRM34PDNSS0500	SMDP20-34027H
SRM14PDNSS0600	SMDP20-14026H1	SRM20SDNSS0600	SMDS20-027H1	SRM34PDNSS0600	SMDP20-34027H1
SRM14PF0000	SMP20-14SL	SRM20SF0000	SMS20-20SL	SRM34PF0000	SMP20-34SL
SRM14PM0000	SMP20-14SK	SRM20SM0000	SMS20-20SK	SRM34PM0000	SMP20-34SK
SRM14PN0000	SMP20-14026	SRM20SN0000	SMS20-20026	SRM34PN0000	SMP20-34026
SRM14PN0500	SMP20-14026H	SRM20SN0500	SMS20-026H	SRM34PN0500	SMP20-34026H
SRM14PN0600	SMP20-14026H1	SRM20SN0600	SMS20-026H1	SRM34PN0600	SMP20-34026H1
SRM14PNSS0000	SMP20-14027	SRM20SNSS0000	SMS20-26027	SRM34PNSS0000	SMP20-34027
SRM14PNSS0500	SMP20-14026H	SRM20SNSS0500	SMS20-027H	SRM34PNSS0500	SMP20-34027H
SRM14PNSS0600	SMP20-14026H1	SRM20SNSS0600	SMS20-027H1	SRM34PNSS0600	SMP20-34027H1
SRM14SC0300	SMS20-14SKH	SRM26PC0300	SMP20-26SKH	SRM34SC0300	SMS20-34SKH
SRM14SC0400	SMS20-14SKH1	SRM26PC0400	SMP20-26SKH1	SRM34SC0400	SMS20-34SKH1
SRM14SDC0300	SMDS20-14SKH	SRM26PDC0300	SMDP20-26SKH	SRM34SDC0300	SMDS20-34SKH
SRM14SDC0400	SMDS20-14SKH1	SRM26PDC0400	SMDP20-26SKH1	SRM34SDC0400	SMDS20-34SKH1
SRM14SDF0000	SMDS20-14SL	SRM26PDF0000	SMDP20-26SL	SRM34SDF0000	SMDS20-34SL
SRM14SDM0000	SMDS20-14SK	SRM26PDM0000	SMDP20-26SK	SRM34SDM0000	SMDS20-34SK
SRM14SDN0000	SMDS20-14026	SRM26PDN0000	SMDP20-26026	SRM34SDN0000	SMDS20-34026
SRM14SDN0500	SMDS20-14026H	SRM26PDN0500	SMDP20-26026H	SRM34SDN0500	SMDS20-34026H
SRM14SDN0600	SMDS20-14026H1	SRM26PDN0600	SMDP20-26026H1	SRM34SDN0600	SMDS20-34026H1
SRM14SDNSS0000	SMDS20-14027	SRM26PDNSS0000	SMDP20-26027	SRM34SDNSS0000	SMDS20-34027
SRM14SDNSS0500	SMDS20-14027H	SRM26PDNSS0500	SMDP20-26027H	SRM34SDNSS0500	SMDS20-34027H
SRM14SDNSS0600	SMDS20-14027H1	SRM26PDNSS0600	SMDP20-26027H1	SRM34SDNSS0600	SMDS20-34027H1
SRM14SF0000	SMS20-14SL	SRM26PF0000	SMP20-26SL	SRM34SF0000	SMS20-34SL
SRM14SM0000	SMS20-14SK	SRM26PM0000	SMP20-26SK	SRM34SM0000	SMS20-34SK
SRM14SN0000	SMS20-14026	SRM26PN0000	SMP20-26026	SRM34SN0000	SMS20-34026
SRM14SN0500	SMS20-14026H	SRM26PN0500	SMP20-26026H	SRM34SN0500	SMS20-34026H
SRM14SN0600	SMS20-14026H1	SRM26PN0600	SMP20-26026H1	SRM34SN0600	SMS20-34026H1
SRM14SNSS0000	SMS20-14027	SRM26PNSS0000	SMP20-26027	SRM34SNSS0000	SMS20-34027
SRM14SNSS0500	SMS20-14027H	SRM26PNSS0500	SMP20-26027H	SRM34SNSS0500	SMS20-34027H
SRM14SNSS0600	SMS20-14027H1	SRM26PNSS0600	SMP20-26027H1	SRM34SNSS0600	SMS20-34027H1
SRM20PC0300	SMP20-20SKH	SRM26SC0300	SMS20-26SKH	SRM50PC0300	SMP20-50SKH
SRM20PC0400	SMP20-SKH1	SRM26SC0400	SMS20-26SKH1	SRM50PC0400	SMP20-50SKH1
SRM20PDC0300	SMDP20-20SKH	SRM26SDC0300	SMDS20-26SKH	SRM50PDC0300	SMDP20-50SKH
SRM20PDC0400	SMDP20-SKH1	SRM26SDC0400	SMDS20-26SKH1	SRM50PDC0400	SMDP20-50SKH1
SRM20PDF0000	SMDP20-20SL	SRM26SDF0000	SMDS20-26SL	SRM50PDF0000	SMDP20-50SL
SRM20PDM0000	SMDP20-20SK	SRM26SDM0000	SMDS20-26SK	SRM50PDM0000	SMDP20-50SK
SRM20PDN0000	SMDP20-20026	SRM26SDN0000	SMDS20-26026	SRM50PDN0000	SMDP20-50026
SRM20PDN0500	SMDP20-026H	SRM26SDN0500	SMDS20-26026H	SRM50PDN0500	SMDP20-026H
SRM20PDN0600	SMDP20-026H1	SRM26SDN0600	SMDS20-26026H1	SRM50PDN0600	SMDP20-50026H1
SRM20PDNSS0000	SMDP20-20027	SRM26SDNSS0000	SMDS20-26027	SRM50PDNSS0000	SMDP20-50027
SRM20PDNSS0500	SMDP20-20027H	SRM26SDNSS0500	SMDS20-26027H	SRM50PDNSS0500	SMDP20-50027H
SRM20PDNSS0600	SMDP20-027H1	SRM26SDNSS0600	SMDS20-26027H1	SRM50PDNSS0600	SMDP20-50027H1
SRM14PF0000	SMP20-20SL	SRM26SF0000	SMS20-26SL	SRM50PF0000	SMP20-50SL
SRM14PM0000	SMP20-20SK	SRM26SM0000	SMS20-26SK	SRM50PM0000	SMP20-50SK
SRM14PN0000	SMP20-20026	SRM26SN0000	SMS20-26026	SRM50PN0000	SMP20-50026
SRM14PN0500	SMP20-026H	SRM26SN0500	SMS20-26026H	SRM50PN0500	SMP20-50026H
SRM14PN0600	SMP20-026H1	SRM26SN0600	SMS20-26026H1	SRM50PN0600	SMP20-50026H1
SRM20PNSS0000	SMP20-20027	SRM26SNSS0000	SMS20-26027	SRM50PNSS0000	SMP20-50027
SRM20PNSS0500	SMP20-20027H	SRM26SNSS0500	SMS20-26027H	SRM50PNSS0500	SMP20-50027H
SRM20PNSS0600	SMP20-20027H1	SRM26SNSS0600	SMS20-26027H1	SRM50PNSS0600	SMP20-50027H1



# Cross Reference - Winchester

Winchester/Vishay Dale Rack and Panel Connectors -  
Microminiature, Subminiature, Miniature

Vishay Dale

WINCHESTER	VISHAY DALE	WINCHESTER	VISHAY DALE	WINCHESTER	VISHAY DALE
SRM50SC0300	SMS20-50SKH	SRM75PC0300	SMP20-75SKH	SRM75SC0300	SMS20-75SKH
SRM50SC0400	SMS20-50SKH1	SRM75PC0400	SMP20-75SKH1	SRM75SC0400	SMS20-75SKH1
SRM50SDC0300	SMDS20-50SKH	SRM75PDC0300	SMDP20-75SKH	SRM75SDC0300	SMDS20-75SKH
SRM50SDC0400	SMDS20-50SKH1	SRM75PDC0400	SMP20-75SKH1	SRM75SDC0400	SMDS20-75SKH1
SRM50SDF0000	SMDS20-50SL	SRM75PDF0000	SMDP20-75SL	SRM75SDF0000	SMDS20-75SL
SRM50SDM0000	SMDS20-50SK	SRM75PDM0000	SMDP20-75SK	SRM75SDM0000	SMDS20-75SK
SRM50SDN0000	SMDS20-50026	SRM75PDN0000	SMDP20-75026	SRM75SDN0000	SMDS20-75026
SRM50SDN0500	SMDS20-5026H	SRM75PDN0500	SMDP20-75026H	SRM75SDN0500	SMDS20-75026H
SRM50SDN0600	SMDS20-50026H1	SRM75PDN0600	SMDP20-75026H1	SRM75SDN0600	SMDS20-75026H1
SRM50SDNSS0000	SMDS20-50027	SRM75PDNSS0000	SMDP20-75027	SRM75SDNSS0000	SMDS20-75027
SRM50SDNSS0500	SMDS20-50027H	SRM75PDNSS0500	SMDP20-75027H	SRM75SDNSS0500	SMDS20-75027H
SRM50SDNSS0600	SMDS20-50027H1	SRM75PDNSS0600	SMDP20-75027H1	SRM75SDNSS0600	SMDS20-75027H1
SRM50SF0000	SMS20-50SL	SRM75PF0000	SMP20-75SL	SRM75SF0000	SMS20-75SL
SRM50SM0000	SMS20-5SK	SRM75PM0000	SMP20-75SK	SRM75SM0000	SMS20-75SK
SRM50SN0000	SMS20-50026	SRM75PN0000	SMP20-75026	SRM75SN0000	SMS20-75026
SRM50SN0500	SMS20-50026H	SRM75PN0500	SMP20-75026H	SRM75SN0500	SMS20-75026H
SRM50SN0600	SMS20-50026H1	SRM75PN0600	SMP20-75026H1	SRM75SN0600	SMS20-75026H1
SRM50SNSS0000	SMS20-50027	SRM75PNSS0000	SMP20-75027	SRM75SNSS0000	SMS20-75027
SRM50SNSS0500	SMS20-50026H	SRM75PNSS0500	SMP20-75027H	SRM75SNSS0500	SMS20-75027H
SRM50SNSS0600	SMS20-50026H1	SRM75PNSS0600	SMP20-75027H1	SRM75SNSS0600	SMS20-75027H1

## SIDE MOUNTS

WINCHESTER	VISHAY DALE	WINCHESTER	VISHAY DALE	WINCHESTER	VISHAY DALE
JF-2P	G20P-AB	JF1P-3S-A	WA20P-A	JF2P-2S-BD	WA20P-BD
JF-2S	G20S-AB	JF1P-3S-B	WA20P-B	JF2P-2S-CD	WA20P-CD
JFA1P1S-A	G16P-A	JF1P-3S-C	WA20P-C	JF2S-SP-AC	WA20S-AC
JFA1P1S-B	G16P-B	JF1P-3S-D	WA20P-D	JF2S-SP-AD	WA20S-AD
JFA1P1SH-A	G16P-A-H	JF1S-1P-A	G20S-A	JF2S-SP-BC	WA20S-BC
JFA1P1SH-B	G16P-B-H	JF1S-1P-B	G20S-B	JF2S-SP-BD	WA20S-BD
JFA1S1P-A	G16S-A	JF1S-2P-AB	WA20S-AB	JF2S-SP-CD	WA20S-CD
JFA1S1P-B	G16S-B	JF1S-3P-A	WA20S-A	JF2S-2S	WA20S-ABCD
JFA1S1PH-A	G16S-A-H	JF1S-3P-B	WA20S-B	JF3P-1S-ABC	WA20P-ABC
JFA1S1PH-B	G16S-B-H	JF1S-3P-C	WA20S-C	JF3P-1S-ABD	WA20P-ABD
JFA2H	G16H	JF1S-3P-D	WA20S-D	JF3P-1S-ACD	WA20P-ACD
JFA2P	G16P-AB	JF2P-2P	WA20P-ABCD	JF3P-1S-BCD	WA20P-BCD
JFA2PH	G16P-AB-H	JF2P-2S-AB	WA20P-AB	JF3S-1P-ABC	WA20S-ABC
JFA2S	G16S-AB	JF2P-2S-AC	WA20P-AC	JF3S-1P-ABD	WA20S-ABD
JFA2SH	G16S-AB-H	JF2P-2S-AD	WA20P-AD	JF3S-1P-ACD	WA20S-ACD
JF1P-1S-A	G20P-A	JF2P-2S-BC	WA20P-BC	JF3S-1P-BCD	WA20S-BCD
JF1P-1S-B	G20P-B				

## Notes

---

Vishay Dale







## Notes

---

Vishay Dale





Build **Vishay**  
into your **Design**

## WORLDWIDE SALES CONTACTS

Visit [www.vishay.com](http://www.vishay.com) for product information or select below  
for a current list of sales offices, representatives, and distributors.

### THE AMERICAS

---

#### UNITED STATES

VISHAY AMERICAS  
ONE GREENWICH PLACE  
SHELTON, CT 06484  
UNITED STATES  
PH: +1-402-563-6866  
FAX: +1-402-563-6296

### ASIA

---

#### SINGAPORE

VISHAY INTERTECHNOLOGY  
ASIA PTE LTD.  
37A TAMPINES STREET 92 #07-00  
SINGAPORE 528886  
PH: +65-6788-6668  
FAX: +65-6788-0988

#### P.R. CHINA

VISHAY TRADING (SHANGHAI) CO., LTD.  
15D, SUN TONG INFOPORT PLAZA  
55 HUAI HAI WEST ROAD  
SHANGHAI 200030  
P.R. CHINA  
PH: +86-21-5258-5000  
FAX: +86-21-5258-7979

#### JAPAN

VISHAY JAPAN CO., LTD.  
MG IKENOHATA BLDG. 4F  
1-2-18, IKENOHATA  
TAITO-KU  
TOKYO 110-0008  
JAPAN  
PH: +81-3-5832-6210  
FAX: +81-3-5832-6260

### EUROPE

---

#### GERMANY

VISHAY ELECTRONIC GMBH  
GEHEIMRAT-ROSENTHAL-STR. 100  
95100 SELB  
GERMANY  
PH: +49-9287-71-0  
FAX: +49-9287-70435

#### FRANCE

VISHAY S.A.  
199, BLVD DE LA MADELEINE  
06003 NICE, CEDEX 1  
FRANCE  
PH: +33-4-9337-2727  
FAX: +33-4-9337-2726

#### UNITED KINGDOM

VISHAY LTD.  
SUITE 6C, TOWER HOUSE  
ST. CATHERINE'S COURT  
SUNDERLAND ENTERPRISE PARK  
SUNDERLAND SR5 3XJ  
UNITED KINGDOM  
PH: +44-191-516-8584  
FAX: +44-191-549-9556

**World Headquarters**

Vishay Intertechnology, Inc.  
63 Lancaster Avenue  
Malvern, PA 19355-2143  
United States

One of the World's Largest Manufacturers of  
**Discrete Semiconductors and Passive Components**

© Copyright 2010 Vishay Intertechnology, Inc.  
® Registered trademarks of Vishay Intertechnology, Inc.  
All rights reserved. Printed in Germany.  
Specifications subject to change without notice.

[www.vishay.com](http://www.vishay.com)

VSE-DB0031-1003